

Leicester Street Design Guide

First Edition
June 2020



Leicester
City Council

FOREWORD

This **First Edition** of the Leicester Street Design Guide is published during the unprecedented Covid-19 crisis, giving it a new relevance we could have never imagined when we first embarked on this major project many months ago.

Back then climate change, economic uncertainty and matters of public health and wellbeing acted as a stimulus, but now we have a climate emergency to respond to and all the health, economic and wider social uncertainty that the present pandemic brings.

A decade ago, we began the Connecting Leicester programme. Since then new public squares, improved cycling and walking infrastructure and even wider pedestrianisation of our city has transformed the city's landscape: promoting sustainable, active travel and a healthy economy.

In the intervening years King Richard III's reinterment and Leicester City Football Club's Premier League victory celebrations shone a light on our city. We were proud to show the world our heritage-rich public realm and wider built environment improvements. We're equally proud to welcome thousands of visitors to our streets, parks and venues for our many cultural festivals and events throughout the year.

The Leicester Street Design Guide draws on best practice from within our city, from across the UK and internationally. Whilst our city is unique, the challenges we face are not. Adopting the Healthy Streets Assessment method will help us to identify priorities, consider design options and achieve accessible and consistent street design that recognises the needs of all our residents. We encourage other local authorities to apply this guide, to their unique place, where applicable.

This document is the result of work and input from very many experts and stakeholders. Particular thanks must be given to Brian Deegan of Urban Movement as the City Mayor's Healthy Streets Advisor, Phil Jones Associates who gave specific support for the Planning & Design Element Sheets, Officers of Leicester City Council and those many representatives of disability groups, transport campaign organisations and others, who supported the process to bring this document to fruition.

Finally, it is vitally important to stress that this is a **First Edition** of a document that will adapt and respond as we learn from responses to its application. As the principles are implemented, we will finesse what we hope you'll agree is already a very positive step in the right direction. We commit to bringing forward a **Second Edition** within 18 months.



A blue ink signature of Sir Peter Soulsby.

Sir Peter Soulsby
Leicester City Mayor

A grey ink signature of Councillor Adam Clarke.

Councillor Adam Clarke
Deputy City Mayor –
Environment and Transportation
Councillor for Aylestone

0 INTRODUCTION

0.1 The Character of Leicester	4
--------------------------------	---

3 TRANSFORMING LEICESTER

3.1 Transforming Streets in Stages	42
3.2 Residential Street Design	45
3.3 Walking + Cycling in Harmony	47
3.4 Development + Growth	50

1 STREET DESIGN PRINCIPLES

1.1 Core Principles	6
1.2 Street Types	7
1.3 Healthy Streets Principles	14
1.4 Healthy Streets Process	17
1.5 Economic Balance	21
1.6 Placemaking	23
1.7 Accessibility + Equality	26

4 STREETS IN NEW DEVELOPMENTS

4.1 Process + Design Principles	52
4.2 Design Element Sheets	82

2 STREET DESIGN ELEMENTS

2.1 Link Design	28
2.2 Junction Design	32
2.3 Sustainable Drainage Systems + Greening	37
2.4 Materials + Maintenance	40

Leicester City Council
 City Hall
 115 Charles Street
 Leicester
 LE1 1FZ



0. Introduction

0

0.1 THE CHARACTER OF LEICESTER

Leicester has a history dating back to Roman times. It is one of the few British cities outside London to have a continuous archaeological record from the Roman era to the present day. What may be able to explain its enduring success and prosperity is its strategically important position in the heart of England, and its diversity.

The Roman incarnation of the city, *Ratae Corieltavorum*, was situated at the junction between two important cross-country routes: *Via Devana* from Chester to the provincial capital Colchester, and the *Fosse Way* from Exeter to Lincoln. The navigable Soar river gave access not only to the open sea via the Trent, but also inland shipping routes to cities like Derby, Nottingham and York.

The Grand Union Canal then arrived to connect the city to London. With the coming of the railways, Leicester benefitted from no fewer than three main line rail connections to London, and the city is now served by the M1 motorway and the A46 trunk road among others, which echo the Grand Union Canal and *Fosse Way* respectively.

Over recent history, Leicester has generally slipped into recession later than competing cities, and recovered quicker. This is often attributed to Leicester having strength in diversity: whereas Birmingham and Nottingham for example relied on large employers such as Austin and Raleigh, Leicester's industrial offer was more diverse e.g. textiles, shoes, specialist engineering. Leicester is still the HQ of clothing firm Next.

The Roman street pattern is still evident today in the city centre, as a rectangular grid centred appropriately on the High Cross shopping centre. The opening of High Cross has drawn the retail heart of the city back to the historic centre, with the Market Street area – once the retail core – now emerging as a cluster for the evening economy and smaller, specialist retailers.

Outside the city centre, the Roman roads persist

as not only corridors for movement, but as economic hubs: Belgrave Road, London Road and Narborough Road all provide a vibrant retail and leisure offer in the heart of their suburban communities. Belgrave Road is a destination of national importance for the UK's south Asian community because of the specialist jewellers and clothiers based there. A recent study by the London School of Economics has found Narborough Road to be the most cosmopolitan street in the country, with shopkeepers from over twenty different countries being represented.

This characteristic of strong suburban economic centres is repeated across the city. Queens Road is the heart of the Clarendon Park area, a community of Victorian terraces that attracts creative young professionals as well as students and workers from the nearby Universities. Green Lane Road in the east of the city boasts an original Art Deco cinema still trading independently, showing a mixture of Bollywood and English-language films.

Beyond the inner-city areas typified by intimate terraced streets built close to where citizens worked, Leicester is characterised by expansive housing developments that were municipally driven: e.g. Saffron Lane Estate in the south (1920s/1930s) and New Parks Estate (1940s/1950s) in the west. This gives the city a distinctive suburban character boasting Art Deco gems such as the "Pork Pie" library at Saffron Lane, and the modernist shops and community facilities of New Parks.

In the period following the Second World War road planning in Leicester followed trends typical of other UK cities, with the creation of a high capacity ring road for motor traffic which split the historic core in two, and included several grade-separated junctions where the main radial routes intersected with it.

Under the Mayor's Connecting Leicester policy, the dominance of these roads has been

significantly reduced to open up routes for walking and cycling across the city centre. This has been achieved through schemes such as the removal of the Belgrave Flyover, the filling in of the underpass at The Magazine and the construction of the at-grade 'super crossing' near to the Station.

This document provides up-to-date guidance on how further changes should be made to Leicester's streets and roads to continue this process of favouring walking and cycling as the best way of moving across the city. It is applicable to both existing roads as well as those that are created and modified through development and re-development of the fabric of the city.

This document is split into four sections, the first covers street design principles and establishes typologies for all of Leicester streets. It also introduces the concept of Healthy Streets and shows the process for improving the streets of Leicester in these terms. The first section also covers economic evaluation and placemaking principles.

The second section looks at link and junction design elements and suggests methods that can be used to approach street design so that the needs of all users are accounted for. This section also contains plan drawings of links and junctions that are not frequently used in Leicester at present but are promoted in order to meet the Healthy Streets aspirations.

The third section looks at how the streets of Leicester can be transformed in stages. This section also makes a case for why the treatment of pedestrians and cyclists in Leicester is unique and special. This section concludes by looking at development and how this is best managed.

The fourth section gives a technical appendix for design of many street elements and is a useful reference guide for developers and engineers.

This document is above all, a tribute to the people of Leicester who have always championed innovation and progress.



1. Street Design Principles

1.1 CORE PRINCIPLES

1



Streets are public places for people as well as movement arteries for transportation



Streets are a catalyst for urban transformation and economic prosperity



Streets should strive to meet the needs of all users even in constrained spaces



Street design should respond positively to context



Streets can be transformed in stages

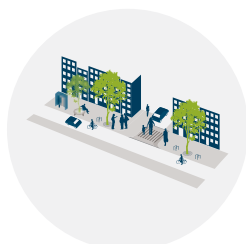

Streets should be sustainable and active by design

1.2 STREET TYPES

Manual for Streets (ref 1) contains a street appraisal system based on movement and place functions. Movement is expressed in terms of traffic volume and network importance whereas place is expressed in terms of significance to people. This approach has been used to define street typologies in Leicester. It is vital that engineering and placemaking approaches are suitable to the street context given by these definitions.

Figure 1 shows the nine different street typologies used in Leicester placed on a movement and place matrix. Note that any one street may have several different classifications. There may also be streets that fall outside of these classifications such as private or industrial access roads but nevertheless it remains a useful framework.

Main Arterial	Arterial Connector	Centre Connector/Hub
Neighbourhood Connector	Neighbourhood High Street	Centre Link
Neighbourhood Residential Street	Centre Calmed Street	Pedestrian Priority Zone

Figure 1 Street Types

The Netherlands have adopted a system called sustainable safety (ref 2) which has five main principles. These principles are: Functionality based on network significance, Homogeneity based on mass speed or direction (this is particularly important for pedestrians and cyclists as it implies separation in high speed/volume locations), Predictability based on design consistency and user expectations, Forgiveness based on the anticipation of road user behaviour and finally State Awareness which places the onus on the individual to assess their capability to undertake tasks associated with street use. These principles are useful in determining what type of approach is suitable for certain street typologies.

Figure 2 shows examples of suitable approaches to street design for each of the nine typologies. In each case a link, side road and a crossing is shown.

Figures 3 to 11 show isometric views of each of the street typologies with suggested generic layouts. It is important to note that not every situation is ideal and that compromises are inevitable due to physical or administrative constraints. In this case Leicester suggests that the road user hierarchy of the city is followed.

This hierarchy places pedestrians first followed by cyclists, public transport, freight and motor traffic. The challenge to designers comes from the lowest priority users requiring the largest amount of space with the lowest efficiency of movement. Efforts should be made to compromise from the bottom up and not from the top down should road space allocation issues arise.

Manual for Streets references three other principal street functions that need to be considered in street design: Access, parking and drainage, utilities and street lighting. Safety issues can arise when a street has not catered for these functions. Adaptability and flexibility of street space can help deliver these functions without compromising the road user hierarchy.

Accessibility is of great importance and every scheme needs to comply with the Equality Act 2010. Therefore, local accessibility needs should be assessed and decisions made following evaluation and consultation.

ref 1. Manual for Streets (2007), Department for Transport, https://www.gov.uk/government/uploads/system/uploads/attachment_data/file/341513/pdfmanforstreets.pdf

ref 2. Background of the five sustainable safety principles, SWOV Institute for Road Safety Research, https://www.swov.nl/sites/default/files/publicaties/gearchiveerde-factsheet/uk/fs_sustainable_safety_background_archived.pdf

movement ^

<p>MAIN ARTERIAL</p> <p>Link: Cycle Track Side Road: Bend Out Crossing: Parallel Signalised Traffic calming: None</p>	<p>ARTERIAL CONNECTOR</p> <p>Link: Full Segregation Side Road: Signalised Crossing: Parallel signalised Traffic calming: None</p>	<p>CENTRE CONNECTOR/HUB</p> <p>Link: Full segregation Side Road: Signalised Crossing: Parallel signalised Traffic calming: Speed limit</p>
<p>NEIGHBOURHOOD CONNECTOR</p> <p>Link: Light Segregation Side Road: Entry treatment Crossing: Zebra Traffic calming: Speed limit</p>	<p>NEIGHBOURHOOD HIGH STREET</p> <p>Link: Adjustable strip Side Road: Continuous footway Crossing: Implied zebra Traffic calming: 20mph zone</p>	<p>CENTRE LINK</p> <p>Link: Adjustable strip Side Road: Continuous footway Crossing: Implied zebra Traffic calming: 20mph zone</p>
<p>NEIGHBOURHOOD RESIDENTIAL STREET</p> <p>Link: Mixed Side Road: Raised table Crossing: Informal Traffic calming: Vertical</p>	<p>CENTRE CALMED STREET</p> <p>Link: Mixed Side Road: Filtered Crossing: Zebra Traffic calming: 20mph zone</p>	<p>PEDESTRIAN PRIORITY ZONE</p> <p>Link: Motor traffic restricted Side Road: Continuous Footway Crossing: Unrestricted Traffic calming: Walking design speed</p>

place >

Figure 2 Sustainable safety approaches for each street typology



Link: Cycle Track
Side Road: Bend Out
Crossing: Parallel Signalled
Traffic calming: None

Figure 3 Main Arterial



Link: Light Segregation
Side Road: Entry treatment
Crossing: Zebra
Traffic calming: Speed limit

Figure 4 Neighbourhood Connector

1

Link: Mixed
Side Road: Raised table
Crossing: Informal
Traffic calming: Vertical



Figure 5 Neighbourhood Residential Street



Link: Full Segregation
Side Road: Signalised
Crossing: Parallel signalised
Traffic calming: None

Figure 6 Arterial Connector

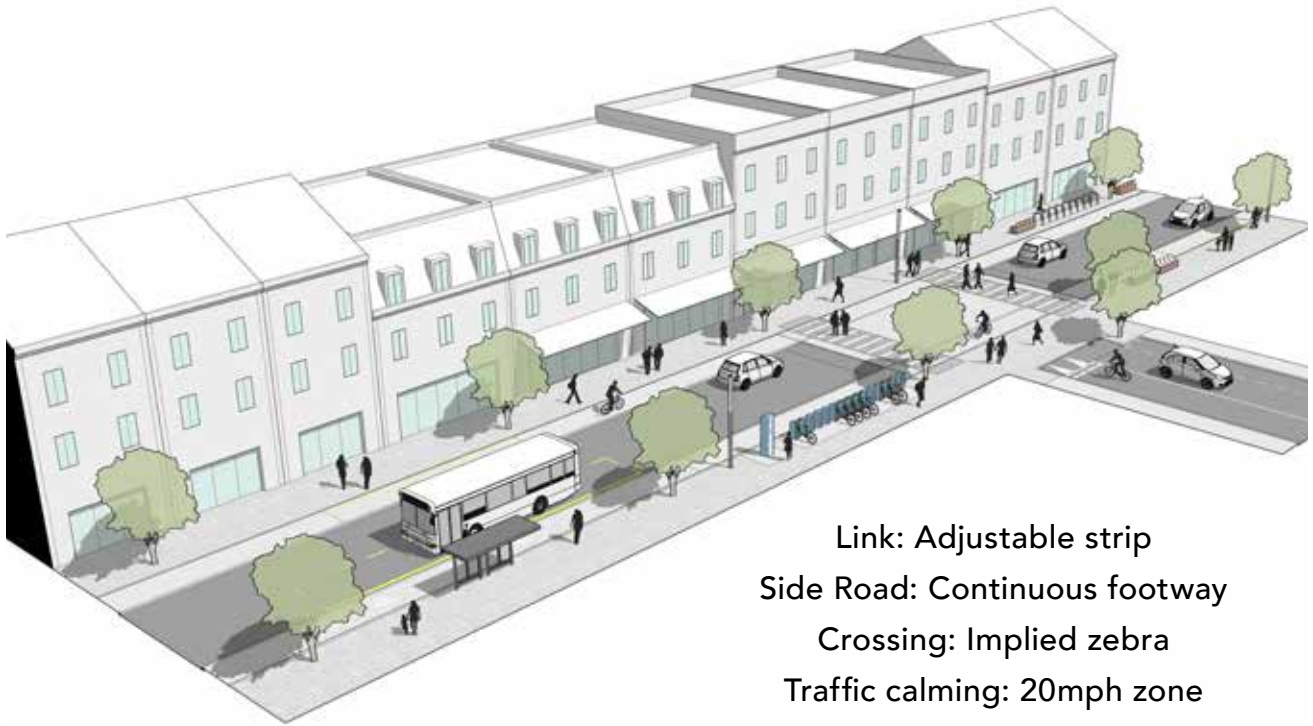

Figure 7 Neighbourhood High Street



Figure 8 Centre Calmed Street

1



Link: Full segregation
Side Road: Signalised
Crossing: Parallel signalised
Traffic calming: Speed limit

Figure 9 Centre Connector/hub



Link: Adjustable strip
Side Road: Continuous footway
Crossing: Implied zebra
Traffic calming: 20mph zone

Figure 10 Centre Link

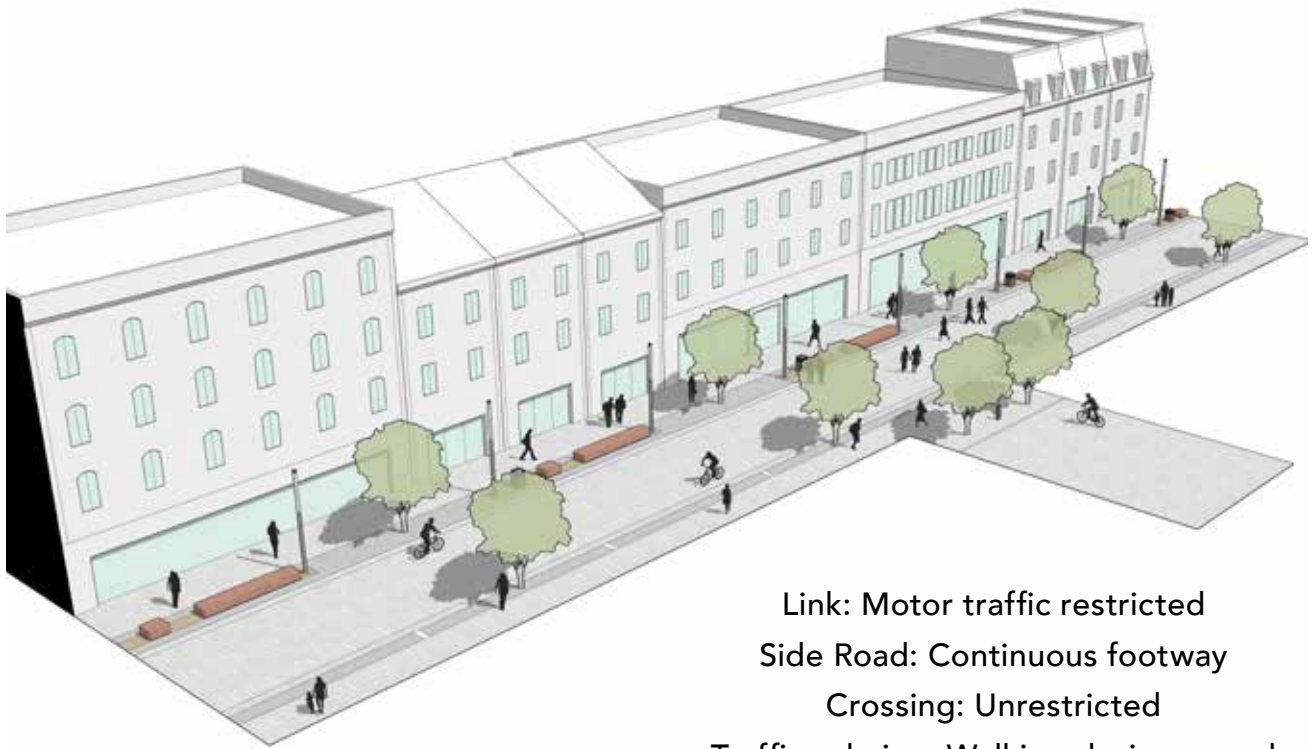

Link: Motor traffic restricted
Side Road: Continuous footway
Crossing: Unrestricted
Traffic calming: Walking design speed

Figure 11 Pedestrian Priority Zone

1.3 HEALTHY STREETS PRINCIPLES

1

People are living longer but unhealthier lives and the design of our streets can either encourage a sedentary lifestyle or promote physical activity. Transport for London has issued several guidance documents on Healthy Streets (ref 3) as well as a tool to help quantify the health-giving properties of a street for street designers.

A healthy street is defined as a street where people are encouraged to walk, cycle or use public transport for everyday trips. Note that this is not a street where people can choose to walk and cycle but rather one where they are actively encouraged to do so through street design choices. It is in the hands of all street designers to assess the health impacts of their schemes and make streets that encourage active travel. There are ten indicators of a healthy street and visual examples of these are shown in Figures 12 to 21.

ref 3: Guide to the Healthy Streets Indicators, Transport for London, 2017, <http://content.tfl.gov.uk/guide-to-the-healthy-streets-indicators.pdf>



Figure 13 Pedestrians from all walks of life



Figure 12 People choose to walk, cycle and use public transport



Figure 14 Easy to cross



Figure 15 People feel safe



Figure 17 Places to stop and rest



Figure 16 Things to see and do



Figure 18 People feel relaxed

1



Figure 19 Not too noisy



Figure 21 Shade and shelter



Figure 20 Clean air

1.4 HEALTHY STREETS PROCESS

Each new scheme design should be assessed using the Healthy Street Check (ref 4) and referenced against the existing condition. By doing this, scheme design quality will improve and the streets of Leicester will become more encouraging to those who choose to walk, cycle or use public transport. Figures 22 to 24 and 26 to 29 show visual examples for some of the metrics associated with the Healthy Street Check. The tool itself will be made available to all those engaged in street design in Leicester. Figure 25 shows the Healthy Street Check applied to London Road.

The Healthy Street Check does not replace any existing procedure but should instead be used alongside them. The Quality Audit process as promoted by the Manual for Streets should be used alongside the Healthy Street Check in order to form a balanced view. The Quality Audit process (ref 5) includes the following:

- audit of visual quality - review of how the streets will be used by the community - road safety audit, including risk assessment - access audit - walking audit - cycle audit - non-motorised user audit - community street audit - Place check audit.

Key stakeholder groups will be engaged throughout the process on significant projects.



Figure 23 Interaction - % of large vehicles

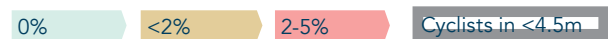

ref 4: Healthy Street Check <https://tfl.gov.uk/cdn/static/cms/documents/healthy-streets-check-for-designers-2018.xlsx>

ref 5: Quality Audit https://www.gov.uk/government/uploads/system/uploads/attachment_data/file/4394/5-11.pdf



Figure 22 Motor Traffic Volume - Total hourly volume of motorised vehicles



Figure 24 Motor Traffic Speed - 85th percentile speed



1



Fig 25 HSC applied

1



1. Motor traffic Volume	1
2. Interaction HGVs	3
3. Motor traffic speed	1
4. Traffic noise	1
5. Noise HGV	2
6. NO2 concentration	1
7. Car reduction	1
8. Side road crossing	2
9. Desire line crossing	2
10. Crossing control	1
11. Movement	2
12. Crossing support	1
13. Walking width	2
14. Shared footway	3
15. Turning risk cyclists	3
16. Cycling width	2
17. Kerbside activity	2
18. Surface cycling	3
19. Surface walking	3
20. Surveillance	3
21. Lighting	3
22. Cycle parking	2
23. Street trees	2
24. Planting	2
25. Resting points	2
26. Shelter	2
27. Bus journey time	3
28. Bus accessibility	3
29. Bus connectivity	3
30. Step free access	3
31. Interchange	2

Highest metric score 3
 Lowest metric score 0
Overall score = 69%
 Existing score = 53% with 6 critical issues



1



Figure 26 Side road crossing - Standard of side road

Closed Treated Dropped only No dropped kerbs



Figure 28 Walking space width - Narrowest point clear of obstruction

2.5m or more 2-2.5m 1.5-2m <1.5m



Figure 27 Collision risk for cyclists - At junctions due to turning movements

Separated <5% turning >5% turning No mitigation



Figure 29 Effective width for cycling - Clear space without obstruction

4.5m or more 4-4.5m <3.2m 3.2m-3.9m

1.5 ECONOMIC BALANCE

In order to make informed and sound economic decisions relating to transport the health impacts, safety benefits and delay caused by congestion, need to be assessed. This chapter shows how to derive costs for each of these three elements and how to weigh them against each other to form a balanced view. This process can be helpful on all schemes in the public realm and should be reserved for major project business cases. Everyone who works in transport should be aware of the impact on these three areas for any change they make.

Health benefits are usually monetised using the Health Economic Assessment Tool (HEAT) and Transport for London has produced guidance (ref 6) on using this approach on Transport Schemes. There are a few useful figures to know to help undertake the assessment. Average daily trip duration is approximately 22mins. 90% return trips reflects the commuting nature of most cycling in Leicester and people cycle for 124 days a year on average. It should be noted that benefits can only be derived or forecasted if pedestrian and cycling numbers are monitored accurately see Fig. 30.

Safety benefits can be derived and forecasted in many ways through collision analysis. The definitive text in this area is Practical Road Safety Auditing published by the ICE. A generic approach is shown in Figure 31 below.

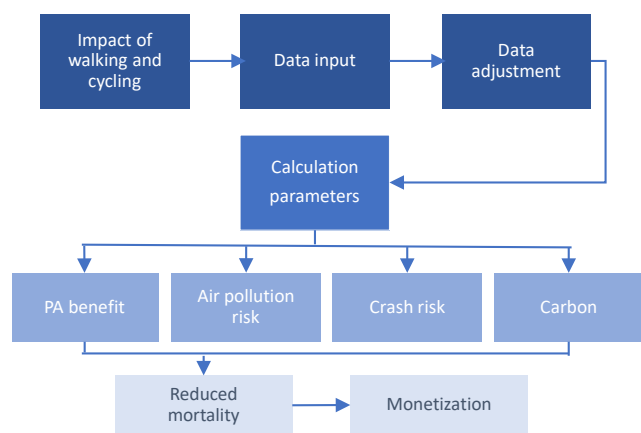

Figure 30 Step by Step HEAT input flowchart

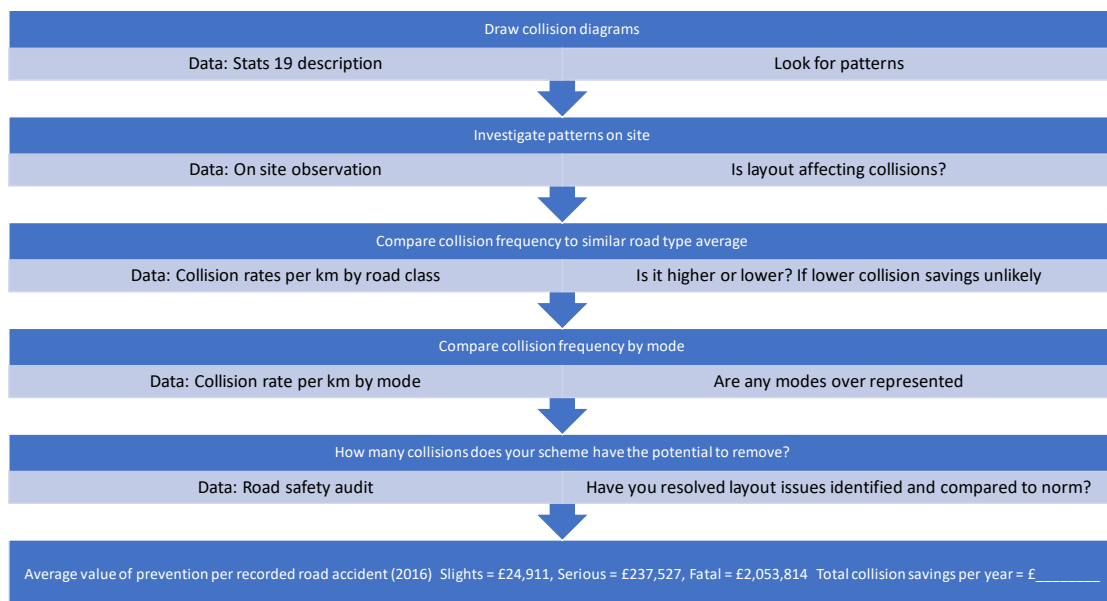

Figure 31 Stages of collision analysis on generic scheme

1

To calculate the cost of congestion the Department for Transport has issued guidance (ref 7) on the calculation of value of time. In practice an average number is often used in assessments of £18 per hour per vehicle.

So for example if a street has 10,000 motor vehicles a day and a proposed scheme brings 20 seconds of delay. Then the annual cost of the scheme is $20[\text{delay}] \times (18/3600)[\text{Value of time converted to seconds}] \times 10,000[\text{daily volume}] \times 340[\text{Annualisation factor}] = \text{£}340,000$.

When using these three methods it is easy to see why most cities put the cost of congestion in the billions and tailor solutions to reduce it. Congestion seems to have a large economic impact. However, just because the calculations are easily derived it does not mean congestion is more important than safety and health.

ref 6. Guide to the Healthy Streets Indicators, Transport for London, 2017, <http://content.tfl.gov.uk/guide-to-the-healthy-streets-indicators.pdf>

A balance needs to be found and health benefits are often on par if not greater than congestion disbenefits for most transformational schemes improving the public realm. Figure 32 below shows one clear way of presenting evidence to senior decision makers for approval.

Schemes are often approved based on their first year rate of return which is a simpler form of benefit costs ratio. A first year rate of return is determined by dividing the benefits by the costs and expressing this as a percentage.

As an example schemes such as Welford Road have a small cost but are generating millions of pounds worth of annual health benefits. In this case collisions and congestion were not an issue and so by traditional analysis this scheme would not be justifiable. By calculating the health benefits this scheme has a very high first year rate of return. Transformational schemes which improve the public realm make sound economic sense.

ref 7. Transport Analysis Guidance: WebTAG, Department of Transport, 2017, <https://www.gov.uk/guidance/transport-analysis-guidance-webtag>



Figure 32 Weighing costs and benefits to find balance

1.6 PLACEMAKING

The Design Companion for Planning (ref 8) and Placemaking contains eight characteristics of successful places. These are illustrated in figures 33 to 40 with Leicester examples.

Consider the following when planning to create these characteristics:

- Patterns of movement and servicing requirements
- Potential for conflicts between users
- Change of use throughout the day
- Maintenance and management
- Ease of movement and desire lines
- Accessibility for all ages and abilities
- Reducing dominance of cars within user hierarchy
- Area connectivity
- Identity of the area
- How the buildings frame and enclose the area
- Proportion of space to buildings
- Effect of buildings on the microclimate
- Landscaping of the area
- Adaptability of street space allocation
- Effect of structure and form on users
- Water and energy needs
- Integration with natural surroundings
- How well appearance expresses function
- Effect of balance, repetition and symmetry on order
- Extent which style matches local vernacular
- Extent to which distinctive identity is applied

ref 8. The Design Companion for Planning and Placemaking, Urban Design London, 2017, RIBA Publishing.



Figure 33 Mix of uses and activities



Figure 34 Fit for purpose

1



Figure 35 Easy movement



Figure 37 Able to adapt



Figure 36 High quality public space



Figure 38 Efficient



Figure 39 Appealing and appreciated appearance



Figure 40 Distinctive, positive identity

1.7 ACCESSIBILITY AND EQUALITY

1

THE EQUALITY ACT 2010

Under the Equality Act 2010, public authorities have a Public Sector Equality Duty (PSED). This means that, in carrying out their functions, including street design, they have a statutory duty to pay due regard to the need to eliminate unlawful discrimination, harassment and victimisation, to advance equality of opportunity between people who share a protected characteristic and those who don't, and to foster good relations between people with different protected characteristics.

Protected characteristics are age, disability, gender reassignment, marriage and civil partnership, pregnancy and maternity, race, religion or belief, sex and sexual orientation. Good street design considers the needs of all users while also paying specific attention to those with protected characteristics, as there is potential for some groups to face greater disadvantage or exclusion if their needs are not properly accounted for.

In addition to the PSED, Section 20(4) of the Act requires that where a physical feature puts a disabled person at a substantial disadvantage (anything more than minor or trivial) in comparison to a person who is not disabled, an authority is required to take reasonable steps to remove the disadvantage. This requirement should be considered as part of any scheme design process.

When deciding whether an adjustment is reasonable you can consider:

- how effective the change will be in avoiding the disadvantage the disabled person would otherwise experience
- its practicality
- the cost
- the organisation's resources and size
- the availability of financial support

COMMITMENT

Leicester City Council has a strong commitment to inclusive design and delivering a network of interconnected routes and public spaces where the highest accessibility standards are in place.

The Connecting Leicester Programme has established what we believe is the largest pedestrian priority network providing full access for people on foot and cycle in the UK. This links public squares and amenities with a comprehensive and accessible network of traffic-free streets or low-traffic roads and routes designed for people not cars.

We are committed to the development of best practice, evidence-based solutions and design considerations that are also bespoke to our unique city. Developing a Leicester Street Design Guide illustrates this commitment. Adopting a Healthy Streets Assessment to assess priorities, options and provide consistent advice and ideas will help to develop consistency and continuity as the Connecting Leicester Programme grows.

Lessons learned in the use of materials, traffic management and tactile paving to offer clear unobstructed access to the city centre will be used as guidance. For example, for guidance in paving or other changes in a consistent way to mark out clear and easy paths to follow for visually or cognitively impaired users, such as those with learning differences, and for the wider benefit of all street users.

APPROACHES

Equality Impact Assessments

The purpose of an equality impact assessment is to influence decision making by identifying and addressing disproportionate negative impacts and, additionally, identifying ways in which we can design to advance equality of opportunity. It helps us to pay 'due regard' to the PSED in advance of deciding which street design to proceed with.

Equality Impact Assessments are undertaken to help identify potential risks and mitigation measures. This may include providing tactile information for those that need it and taking steps to change driver behaviour to ensure that they are aware of not having priority in all scenarios.

In consultation for this document and subsequent

scheme designs our approach is to consider pedestrians, cyclists, disabled people, other vulnerable road users, public transport users and essential car-users as a priority. Where provision for any mode has the potential to have a disproportionate negative impact on people with disabilities or any other protected characteristic, we will take steps to remove or reduce any disproportionate disadvantage or negative impact whilst considering the specific mode of travel.

Cycling infrastructure

There has been a strong recent focus on the impact of cycling infrastructure on accessibility for disabled users. At Leicester we are committed to increasing the number of people cycling as we believe that there are many benefits to encouraging people to take more active and sustainable modes of travel where possible. We also recognise that this must be balanced against the needs of other users, particularly those with a disability, who may experience a disproportionate impact if street design is not inclusive and accessible. This can be achieved with well-considered design where the proposal or options have been equality impact assessed.

Junction Design

Currently, in the UK there is an overall imbalance in street design, where the needs of car users take precedence over the needs of pedestrians and cyclists. For example, UK signal-controlled junctions give a great time and space advantage to those travelling by car over pedestrians and cyclists. It is not uncommon for complex junctions to take several minutes to cross on foot or cycle and those with disabilities can often feel this disadvantage more acutely. This is currently standard practice across the UK and Leicester City Council want to positively address this.

The junction design section of this document (2.2) identifies that new ideas may be needed in the attempt to establish a fair and level playing field for those who walk and cycle. In addition, we recognise that under the Equality Act it is

acceptable to address barriers faced by disabled people with more favourable treatment when needed.

Side Roads

The simple act of crossing a side road can be filled with uncertainty and fear. Leicester want to tackle this through new approaches to side road design which give a clear visual indication to those that drive that people walking and cycling have priority. Continuous footways help to recover priority for those who do not drive. However, this aim has gained criticism from some visually impaired advocate groups who feel they may be exposed to turning traffic without warning. Leicester's approach will be to use this design with care only in the most appropriate contexts.

Cycling Bypasses at Bus Stops

Bus stop bypasses for cycling have been raised as a concern by disability groups and we will assess any new bypasses that we propose to deliver in Leicester and will design to mitigate any potential disproportionate disadvantage to people with disabilities. We are considering options to increase the accessibility of bus stop bypasses and considering how we ensure that we promote sustainable modes of travel.

Stakeholders

Leicester will work with users, and advocate groups, who may experience disproportionate impacts unless mitigated, when planning and designing streets. We will make decisions based on a range of evidence including the views and needs of those protected under the Equality Act 2010. We need to continue to consider the needs of those with disabilities in depth as part of the design process to ensure that we remove barriers to access and advance equality of opportunity. Whilst there is a focus on increasing sustainable and active travel, the needs of those who use a car because they cannot walk, cycle or use public transport will also need to be considered.

2. Street Design Elements

2.1 LINK DESIGN

2

London's Better Streets (ref 9) documentation offers six design considerations that act as a useful framework for engaging in street design. These are shown and illustrated in Figures 41 to 46. These principles are best employed when planning major public space projects that aim to transform neighbourhoods. This documentation contains the following passage which ties in with the core principles of this document:

"Because well designed streets must be sensitive to location and context, the key to their successful creation is found less in highway design manuals than in the imaginative application of certain principles to the design of the public realm."

ref 9: Practical Steps to Better Streets referenced in Better Streets Delivered www.urbandesignlondon.com/wordpress/wp-content/uploads/better-streets-delivered-web-version.pdf



Figure 42 Imagine a blank canvas

Every feature needs to be justified. Minimise clutter from signage, lighting and materials.

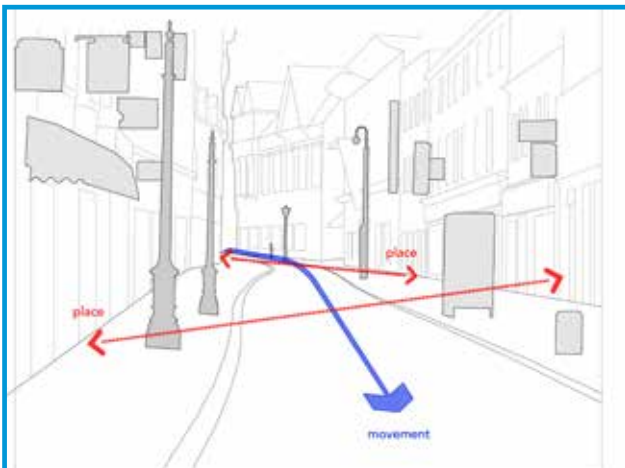

Figure 41 Understand function

Decide the street type based on movement and place function. Heavy pedestrian areas should make segregation less likely.



Figure 43 Decide on the degree of separation

Segregation of road users should be avoided. People can act responsibly.



Figure 44 Reflect character

The street is the foreground to the buildings and the buildings frame the street.



Figure 46 Go for quality

Use the highest quality and most durable materials affordable. Attention to detail makes a big difference.



Figure 45 Avoid over-elaboration

A street is the stage, not the star. Building, trees and activities create great streets.

2

Most streets have been designed with the movement of motor traffic in mind and as such most of the design work in urban centres is concerned with retrofitting to mitigate the resulting road danger. This is particularly the case with cycling which has been routinely omitted from road space allocation discussions in the UK for over 60 years.

When designing for cycling on links the most relevant design consideration is the decision over the degree of separation. The desire to separate cyclists from other road users will depend on the street typology. However, people actively considering switching to cycling will often demand segregation as an entry requirement. For example, a recent paper by Dr Rachel Aldred suggested that high quality cycling infrastructure might diversify and normalise cycling in low cycling contexts.

The London Cycling Design Standards attempted to define what level of separation was suitable for each street context but the choice to separate must be weighed against the need to entice new users and the impact on the other principles. Figures 47 to 51 show several degrees of separation for cycle routes as well as associated profiles.

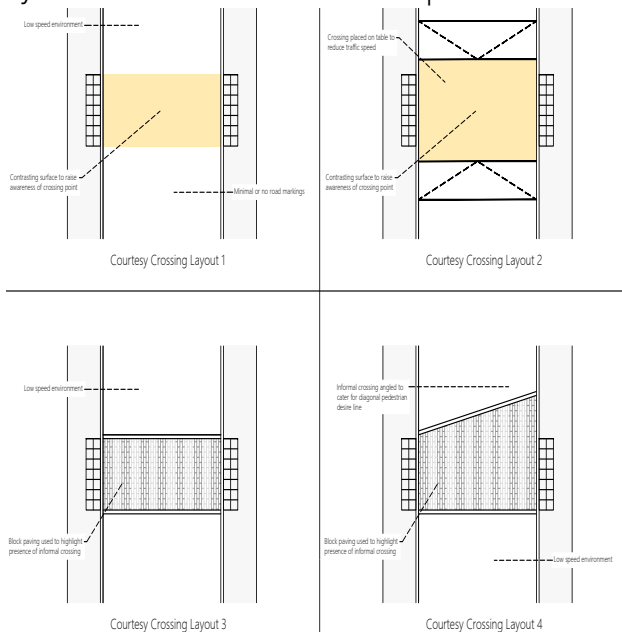

Figure 47 Examples of courtesy crossings

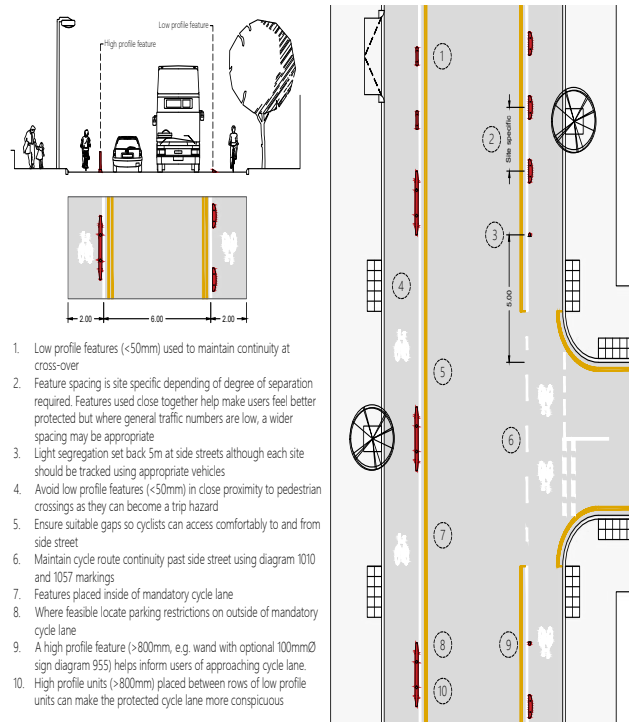

Figure 48 Light segregation arrangements

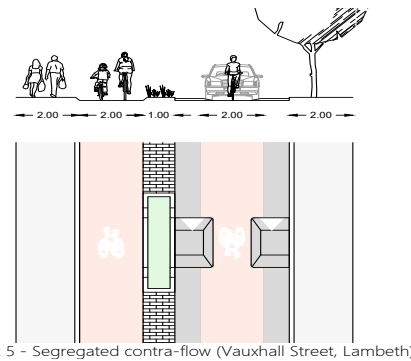

Figure 49 Cycle Street by design

ref 10. Diversifying and normalising cycling in London, UK: An exploratory study on the influence of infrastructure. Rachel Aldred and John Dales, 2017 Elsevier, <http://www.sciencedirect.com/science/article/pii/S2214140516303978>

ref 11. London Cycling Design Standards, Transport for London, 2014, <https://tfl.gov.uk/corporate/publications-and-reports/streets-toolkit>

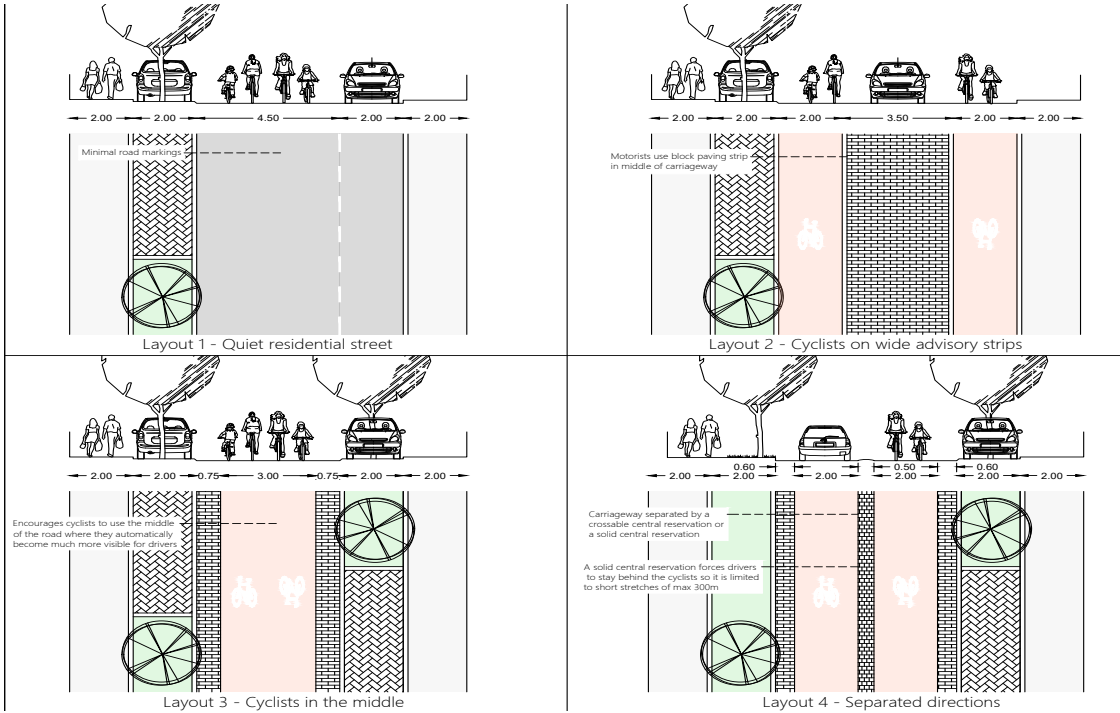

Figure 50 Mixed Streets treated as cycle streets

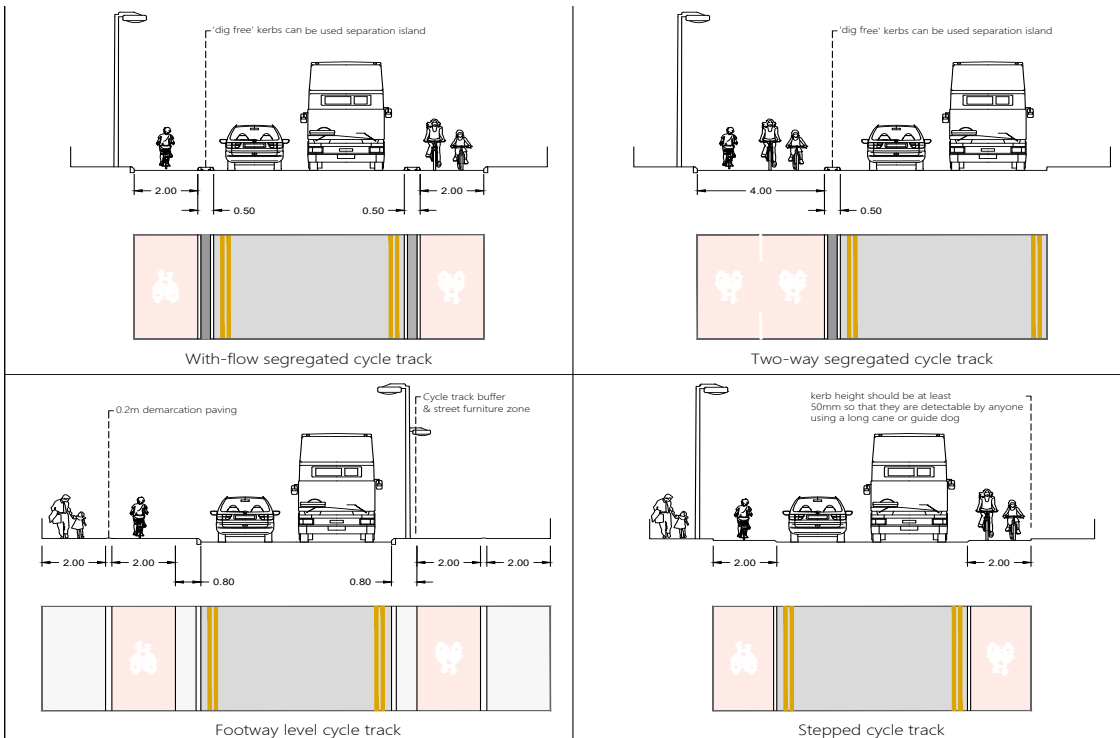

Figure 51 Mixed streets

2.2 JUNCTION DESIGN

Junction design is about managing conflict and the key consideration is how to minimise the risks involved in these conflicts. Design responses will vary from encouraging and promoting negotiation in integrated street contexts to full separation in both time and space on strong movement corridors. Figures 52 to 58 are intended to promote new innovations in junction design that can help promote walking and cycling and deliver healthy street objectives.

When designing for cyclists on links and junctions care must be taken when managing positional transitions. As a general rule a recommended link position should be decided at the junction and maintained until the next junction. Any infrastructure that suggests cyclists move between primary and secondary position mid link should be avoided. This issue is commonly created by pinch points. Figure 59 shows how a consistent position is maintained.

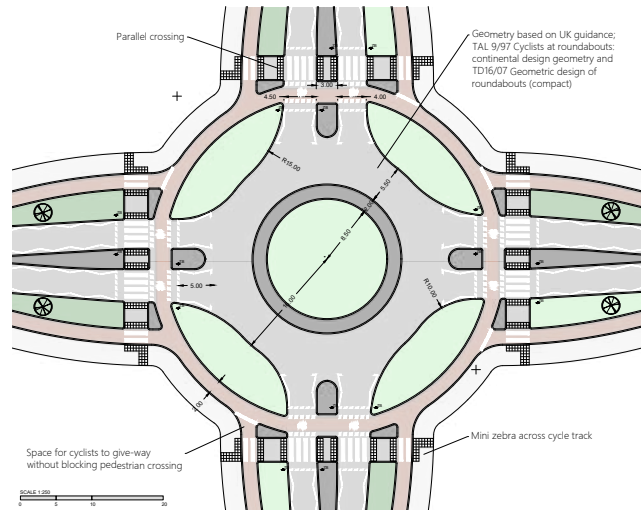

Figure 53 shows a major cycle friendly roundabout

Variations: Set back cycle crossing, turbo lanes, signalised

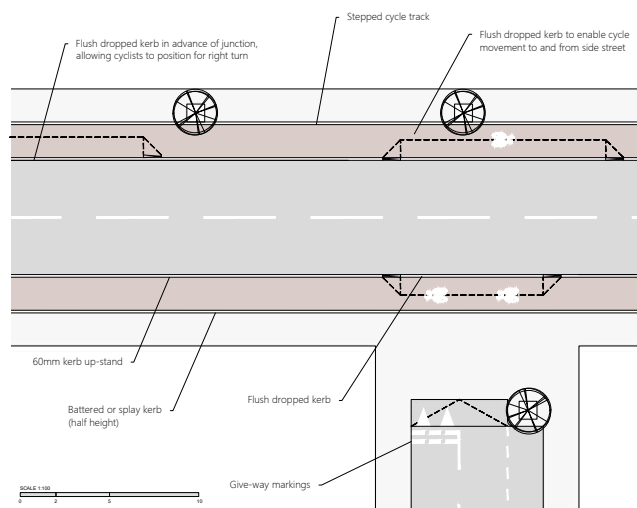

Figure 52 Priority junction layout with continuous footway and cycle track

Variations: Flush zebra, tactile retained, mouth of junction retained

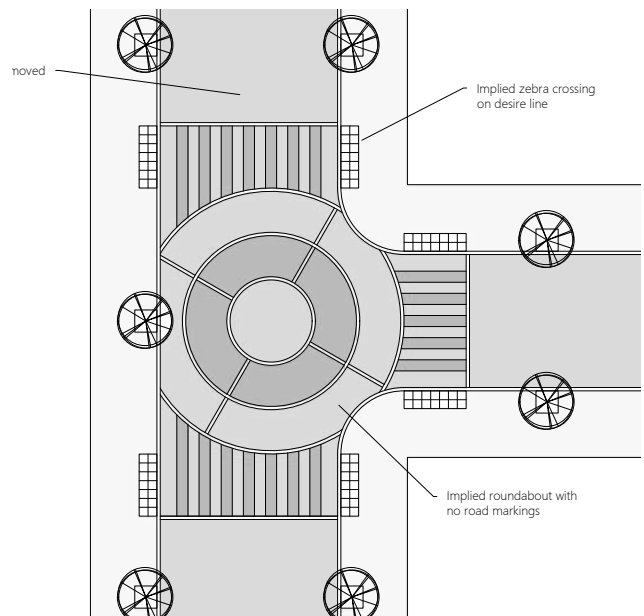

Figure 54 shows an implied roundabout

Variations: Shared or parallel cycling movement, all arms give way

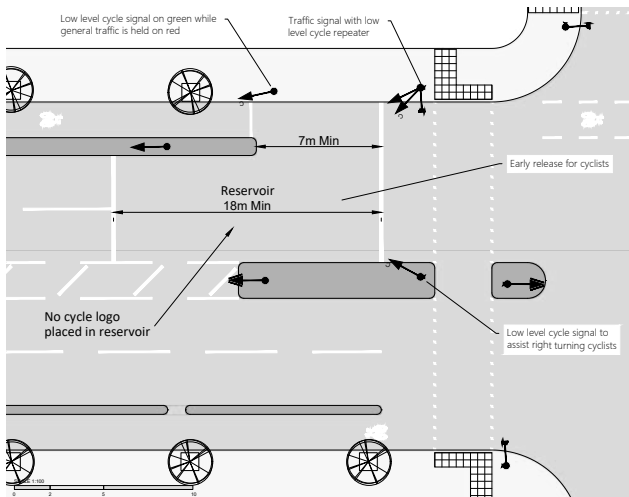

Figure 55 shows a cycle gate with early start

Variations: <15m depth feasible for reservoir, merge from footway or median for cyclists into gate

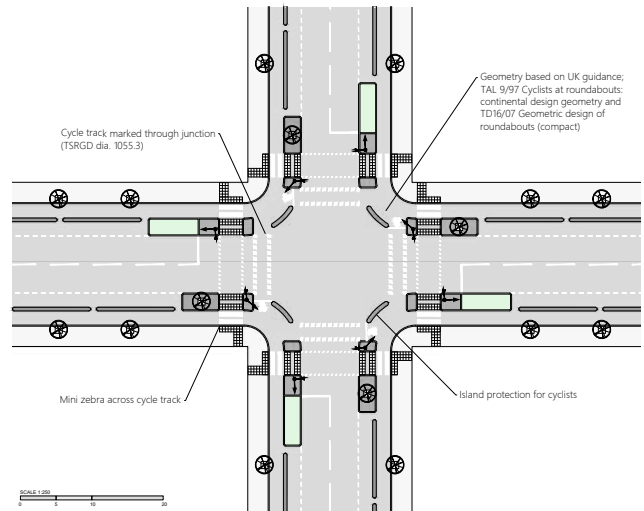

Figure 57 shows a protected junction

Variations: Courtesy offset crossing of cycle track, stop lines for cyclists with full signalised crossing for pedestrians, diagonal movements permitted

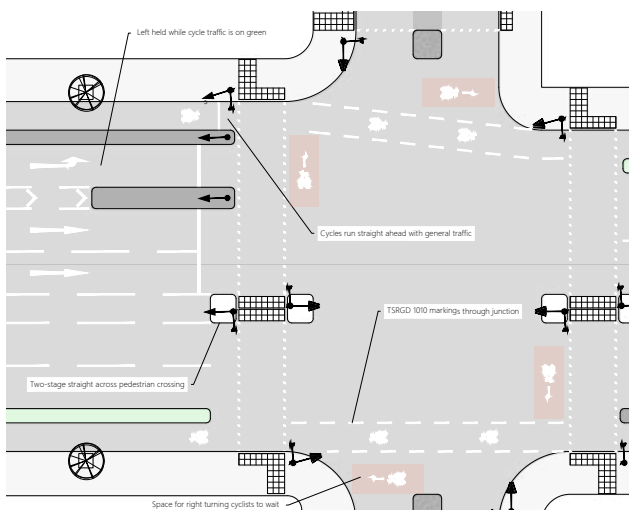

Figure 56 shows a hold the left junction with 2 stage right turn

Variations: Used on all arms with left turn cycle bypass

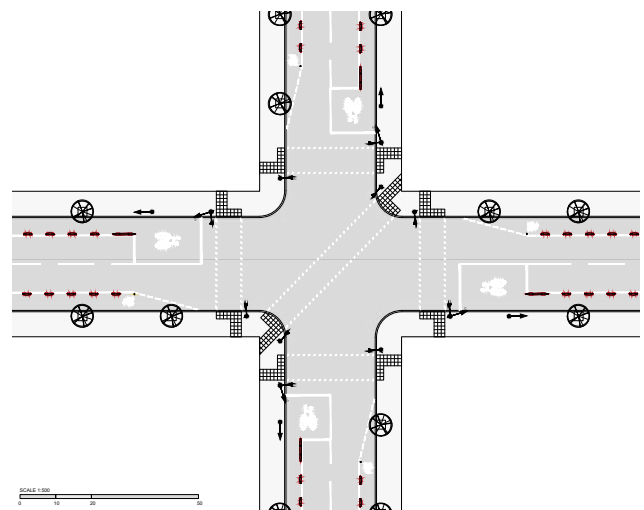
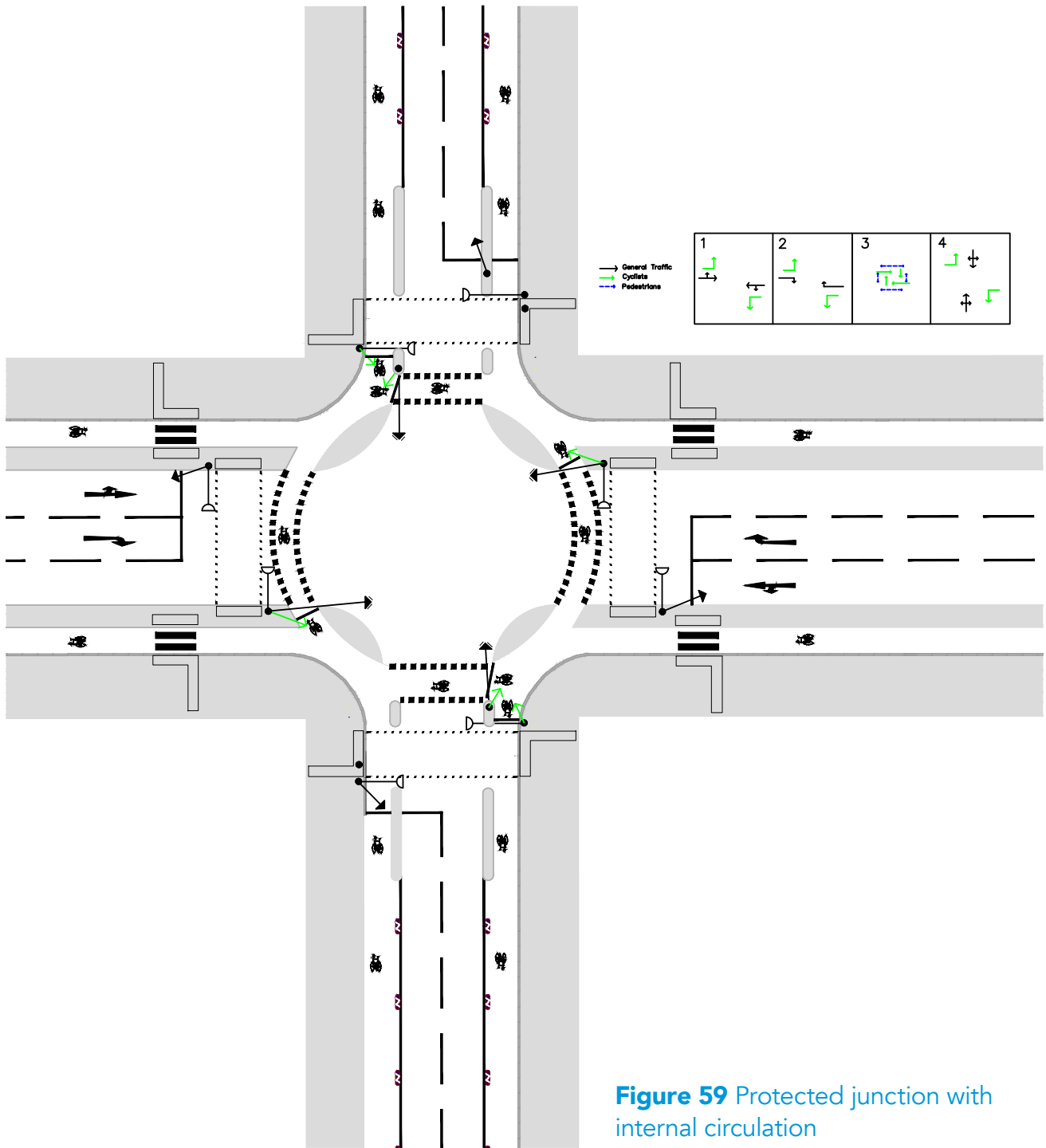
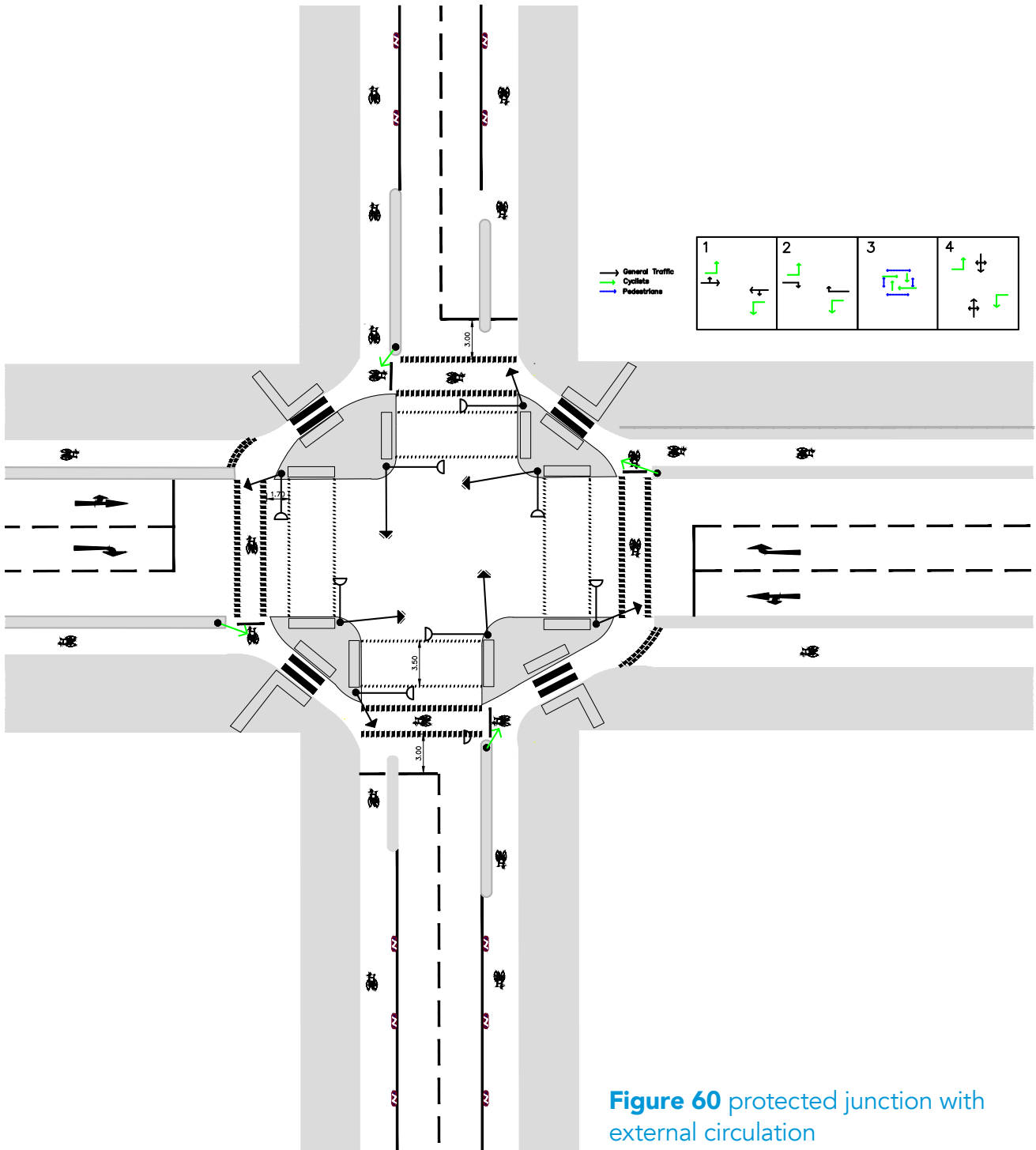

Figure 58 shows a diagonal crossing

Variations: Double diagonal, shared scramble



This approach is similar to the type used in Waltham Forest and attempts to recreate the Dutch approach to junction design. A typical layout and method of control is shown.



This approach is a variation on the Greater Manchester protected junction approach. A technical note on this approach is available from <https://tfgm.com/news/new-junction-design>. A typical layout and method of control is shown.



Figure 61 Consistent positioning

Recommended link position should not change between nodes. Any attempt to prioritise walking and cycling through road space reallocation and junction adjustment will influence traffic capacity. Figure 62 shows the predicted extent of that impact for each new junction type referenced above. These figures are based on practical experience and are presented in order to promote approaches to mitigation and not to discourage adoption.

JUNCTION APPROACH	ESTIMATED IMPACT ON CAPACITY	SUGGESTED MITIGATION
Major Cycle Friendly Roundabout	-30%	Area reassignment
Implied Roundabout with Implied Crossings	-20% to +20% (depending on pedestrian flows)	None required as only justifiable where impact is positive
Cycle Gate with Early Start	-10%	Resolve journey time impacts with minor link adjustments
Hold the Left with Two-Stage Right	-20%	Ban turns
Protected Junction	0% - 20% (depending on the presence of all pedestrian stage)	Resolve journey time impacts with minor link adjustments
Diagonal Crossing	-5%	None required

Figure 62 Capacity implications for junction design approaches

To conclude this section on new ideas for street design we should consider the allocation of space in the highway and what space can potentially be used for multiple uses. Parking and loading space is often excessively provided even in places where there is a high pedestrian footfall and narrow pavements. This situation can diminish the health-giving properties of the street as social spaces and also mean that seating may not be feasible.

One solution is to consider the use of parklets. If space in between or alongside parking and loading can be re-purposed, then many street improvements can be made. For example, cycle parking could be introduced here rather than obstructing footway space or forcing cyclists to mount kerbs to park. Seating could be provided to enable those who need a rest to have a place to sit and socialise. Trees or planting could be provided to improve air quality and make the area feel more relaxed. Electric Vehicle charge points could also be accommodated on parklets to reduce the risk of tripping from wires across the footway.

Kerbside carriageway space should be considered for all these uses and the parklet concept allows temporary trials of this arrangement. Cafe's may wish to remove parking provision to provide extra space for customers and much of this could be done with little impact on business or residential parking commitments. An example is shown in Figure 63 below.



Figure 63 A simple temporary parklet

2.3 SuDS + GREENING

Leicester City Council has an approved Sustainable Drainage Guide (SDG), published in February 2015 (ref 11) , and its advice should be read in addition to this document. The LCC SDG is aimed at property developers, but its principles and techniques are equally applicable to streets and other public spaces. It presents three types of Sustainable Drainage Systems (SuDS), which are in fact interlinked, see Figure 64. The techniques are not mutually exclusive and can work in a chain from local to regional in scale. The source control and site control techniques are most easily applied at the level of streetworks project, however major schemes may necessitate thought to be given to regional control.

ref 11. Sustainable Drainage Guide, leicester City Council. <https://www.leicester.gov.uk/media/179759/suds-guidance-april-2015.pdf>

As a general guide, the further along the sustainable drainage scale and the larger in size of the intervention, the more significant its impact is on place. But on the other hand, the scale of a street also influences the scale of drainage system that can be implemented, and SuDS has significant potential to contribute to placemaking in streets of all types. Therefore, source control and site control mechanisms can be designed in to a street and should be viewed as being complementary to the layout, rather than a threat.

There may be a short iterative design process between landscape architects and drainage engineers to come to a view on the types of systems that can be most usefully incorporated into a street or public space, but figure 65 offers a guide to scale and scope of interventions that are most likely. Figures 66 to 69 show Leicester examples of SuDS in practice.

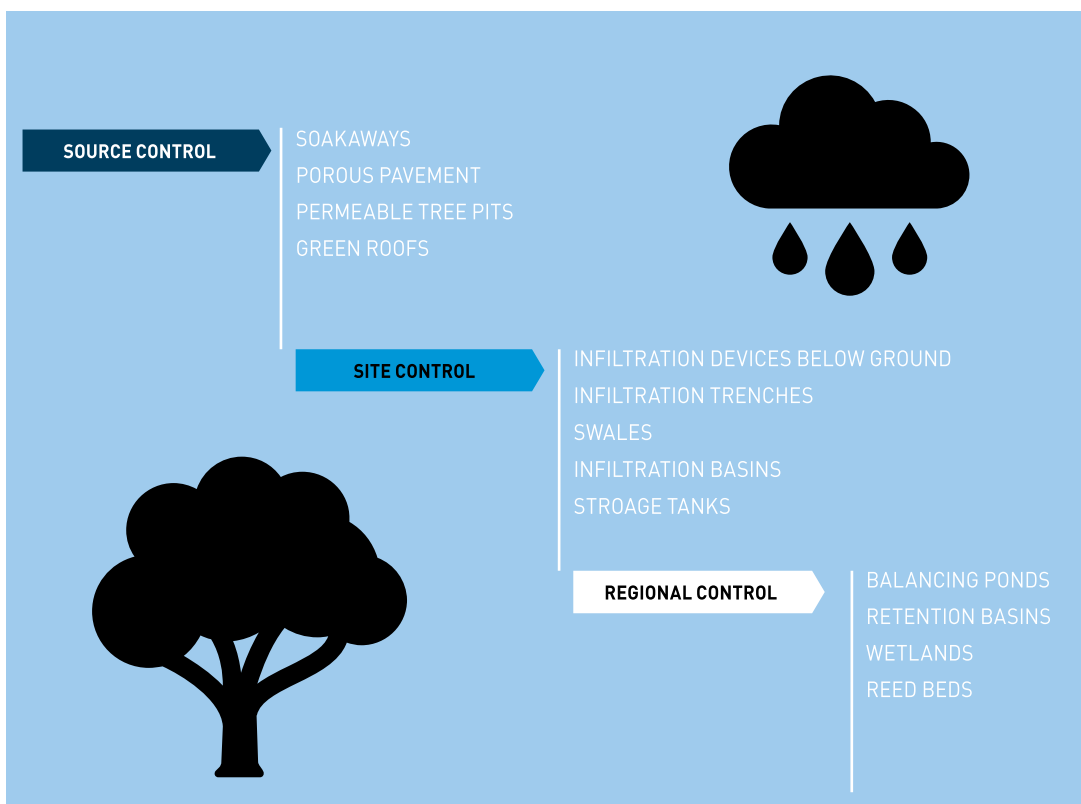

Figure 64 SUDS approaches to control

<p>MAIN ARTERIAL</p> <p>A main arterial route could be flanked by a significant length of sustainable drainage, i.e. a site control feature. In a dual carriageway, this could also be located in the central reserve.</p>	<p>ARTERIAL CONNECTOR</p> <p>SuDS techniques here will be simple, but could be numerous. Paving materials can be permeable, parking areas can be demarcated with soakaway tree pits, and verge areas can be laid out as rain gardens.</p>	<p>CENTRE CONNECTOR/HUB</p> <p>Significant opportunity for SuDS to contribute to place-making – certainly a site control feature, and perhaps a regional control system as part of a very large scheme.</p>
<p>NEIGHBOURHOOD CONNECTOR</p> <p>SuDS techniques here will be simple, but could be numerous. Paving materials can be permeable, parking areas can be demarcated with soakaway tree pits, and verge areas can be laid out as rain gardens.</p>	<p>NEIGHBOURHOOD HIGH STREET</p> <p>Heavier footfall may rule out extensive use of soft landscaping, but used effectively, a site source or control system could form a key feature in the street.</p>	<p>CENTRE LINK</p> <p>Heavier footfall may rule out extensive use of soft landscaping, but used effectively, a site source or control system could form a key feature in the street.</p>
<p>NEIGHBOURHOOD RESIDENTIAL STREET</p> <p>SuDS techniques here will be simple, but could be numerous. Paving materials can be permeable, parking areas can be demarcated with soakaway tree pits, and verge areas can be laid out as rain gardens.</p>	<p>CENTRE CALMED STREET</p> <p>Heavier footfall may rule out extensive use of soft landscaping, but used effectively, a site source or control system could form a key feature in the street.</p>	<p>PEDESTRIAN PRIORITY ZONE</p> <p>Heavier footfall may rule out extensive use of soft landscaping, but used effectively, a site source or control system could form a key feature in the street.</p>

Figure 65 SuDS approaches based on street context

The Council has a tree strategy (ref 12) covering the maintenance and management of the tree canopy as well as encouraging trees on private land.

ref 12. Tree Strategy, Leicester City Council. <https://www.leicester.gov.uk/your-council/city-mayor-peter-soulsby/my-vision/tree-strategy/>

There are many benefits of taking the SuDs and greening approach including traffic calming, reduced anti-social behaviour, increased property prices, tourism, air quality, cooling and shading and creating more pleasant places to walk and cycle.



Figure 66 Linked rain gardens on Mill Lane



Figure 68 Permeable paving on Humberstone Gate



Figure 67 Permeable resin bound-surfaced tree pits on Applegate



Figure 69 Living wall at University medical sciences building

2.4 MATERIALS + MAINTENANCE

Choice of materials plays an important role in contributing to the quality of a space or place, but it is essential to remember that good materials can never make up for poorly conceived or executed design. Specification of materials will need to reflect the specific context of the street, and the case for higher quality and bespoke materials will reflect the place context.

A simple palette of materials can assist with wayfinding and legibility: people generally recognise “black top” as being carriageway space, and kerbs as representing the end of one type of space and the start of another. Making the decision to respect or disrupt this natural order is essentially part of the design process: the specification of materials will need to understand the original intentions of the designer, otherwise the fundamental principles of a scheme may be lost. Therefore, this section should be read alongside the rest of this document, so that materials are understood as being one ingredient of many things that make a good street or place.

There will be a tension between quality of materials, and the ability to keep such materials in a serviceable condition. Bespoke materials or hard-to-source materials will be unlikely to be maintained by statutory undertakers (utility companies), and quickly a street will start to look chaotic with patching and substitute materials in place.

Using common materials that can be easily sourced can help to extend the working life of a scheme. Indeed, cheap and even temporary materials have been put to good use to demonstrate the principles of positive changes to streets, for example parklets (see figure 70), bollards, or movable planters to reconfigure carriageway space cost-effectively and quickly. See figure 66 for a summary of the benefits of using common or bespoke materials.

FACTORS TO CONSIDER WHEN CHOOSING MATERIALS:

Vehicle loading – heavy vehicles will damage setts and even tarmac; the construction of suitable footings will need to be factored in, and may not be possible if the street closure required is too disruptive.

Buried services – utility covers may not be suited to certain types of material. Forthcoming maintenance requirements should be understood as significant street works may disrupt the finish very quickly. Encourage utility companies to bring forward maintenance or carry it out as part of any works. A design may even provide drawpits and duct runs to future-proof new utility works.

Cleaning and maintenance – materials should be easy to clean and maintain, and not cost prohibitive to replace or repair.

Conservation status – most conservation areas have a character appraisal that may influence the choice of materials.

Listed buildings – these may justify a change of material to create a “footprint” for the building within the street itself, for example.

Street uses – places with a concentration of hot-food takeaways will be subject to oil staining, which can be emphasised or subdued in different materials. The same applies to areas where vehicles dwell for long periods, e.g. bus stops, loading bays and parking areas.

Legibility and accessibility – does this material sufficiently communicate to users what they are expected to do? Extensive use of one colour of material can present difficulties for visually-impaired users whose residual vision still allows them to detect changes in colour. The choice of material should reflect the road user hierarchy.

	BESPOKE	COMMON
BENEFITS	Helps a street or area stand out from the rest	Easily maintained, cheaper, more likely to be accepted by developers Consistent – people are familiar, but...
DRAWBACKS	Difficult to maintain, expensive to fit and renew May not deliver the full benefits without good overall design What is in fashion today, may look dated in 10 years	...lacks the wow factor – everything looks the same May limit the ability to emphasise “place” or specific context “moments” The “so what?” factor – people may be sceptical of change if the materials are not high spec
GENERAL PRINCIPLES	High footfall areas Areas of significant cultural, economic or historic value	Lighter footfall areas Areas will less place significance Locations with specific requirements, e.g. where vandalism or heavy vehicle loading is prevalent

Figure 70 Choice of materials summary table

- Vehicular crossovers – these should be laid out in the same material as the footway adjacent, so the continuity is emphasised. Legally, vehicular crossovers are spaces where pedestrians have absolute priority, so laying them out in a carriageway-type material, or a material that contrasts with the footway communicates the opposite message.

- Cycleways and shared cycleways – it may be desirable to lay these out in different materials and colour to footways and carriageways to provide a consistent street language. This is seen in the Welford Road scheme, where the dedicated cycle track is red/burgundy, which contrasts with the buff coloured footway, and the grey/black areas of shared use. On other places, where older cycle tracks are in place, green tarmac or surface dressing has been used for cycle tracks. While the colour is different, the principles are the same.

While the colour is different, the principles are the same.



Figure 71 Contrast legibility strip in the city centre



Figure 72 Planters as interim buildouts on Braunstone Gate, Leicester

3. Transforming Leicester

3.1 TRANSFORMING STREETS IN STAGES

Urban Design London's Better Streets Delivered (ref 13) document contains a good step by step guide to improving the quality of a street with options ranging from minor to major. These steps are illustrated on figures 73 to 77. These steps are applicable to all streets.

3

When designing healthy streets sometimes small changes can have big impacts as referenced in Transport for London's guide to tactical urbanism (ref 14). Figures 73 to 75 show some approaches to consider.

There are three basic conditions that need to be in place before any transformation can take place. These are speed limit management, controlled parking and area traffic management. Design speeds of 20mph open many street design options that are not feasible at higher design speeds. Controlled parking zones restrict parking opportunities and as such protect the character of an area and provide consistent manageable volumes of motor traffic. These two methods are well known but the process of adjusting traffic flow to improve conditions for active travel is less well known.

The most successful approach is filtered permeability championed by the academic Dr Steve Melia (ref 15). This approach has been used successfully in Leicester to promote walking and cycling. Figure 76 shows how this approach has been successfully applied in Leicester. The blue line shows the circular access road and the red lines show the filter points. Pedestrians and cyclists can pass through these filter points, but motorised traffic cannot. The key to the filtering is that there are no possible through routes for motorised traffic so walking and cycling is promoted as the logical choice for short trips.

ref 13. Better Streets Delivered, Urban Design London, <http://www.urbandesignlondon.com/wordpress/wp-content/uploads/better-streets-delivered-web-version.pdf>



Figure 73 Tidy Up

In this example A boards are removed but anything unwanted or broken could be removed. If the footway is damaged when removing objects then repairs should be made.



Figure 74 De-clutter

Justify every piece of equipment particularly those causing obstruction. Assume it should be removed unless there is a strong case to retain it. Signs, guardrails and bollards are the main items. In this case bollards have been highlighted.



Figure 75 Relocate or merge functions

Whatever furniture remains should work together. think about creating a furniture zone to create a clear walkway for pedestrians. In this case lighting columns have been merged with traffic signal poles. Lighting could also be mounted on buildings and multiple signs put on the same post.



Figure 77 Recreate the street

Think about remodelling the space to make it feel like a different place. Kerbs and level differences could be removed to provide pedestrian priority.

Ref 14. Small Change, Big Impact, Transport for London, <http://content.tfl.gov.uk/small-change-big-impact.pdf>

Ref 15. Melia, S. (2012) Filtered and unfiltered permeability: The European and Anglo-Saxon approaches. <http://eprints.uwe.ac.uk/16905/1/Filtered%20Permeability%20-%20For%20Project.pdf>



Figure 76 Rethink traffic management options

Think about rebalancing priorities in favour of pedestrians and cyclists. In this case traffic signals have been removed and pedestrian crossing movements prioritised with the presence of a raised zebra crossing.



Figure 78 Colourful crossing example



Figure 80 Trial closure and creating of a temporary public space



Figure 79 Parklet replacing parking spaces

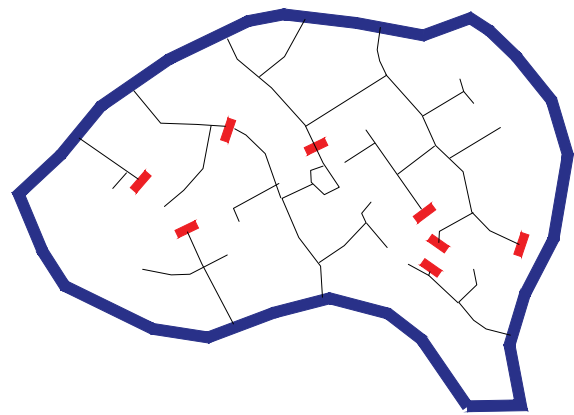

Figure 81 Filtered permeability in the Beaumont area of Leicester

3.2 RESIDENTIAL STREET DESIGN

The most important street to everyone, is the street where they live. Yet neighbourhood streets are often the most neglected: ranked low in terms of maintenance and overlooked in strategic transport plans. Collisions rarely take place on them and the only times they gather attention is if they are discovered as “rat-runs” by “street wise” drivers. Neighbourhood streets were once the vibrant epicentre of UK street life with kids playing and parents chatting. These days they can often feel like deserted car storage depots.

One of the tragedies of UK planning in the last 50 years has been the desire to model residential street layouts on those of far busier roads. Be that through widening junction radii to enable refuge trucks to take corners at 30mph or providing high grip smooth surfaces where motor traffic can pass through at intimidating speeds.

The result of this automotive fixation is that people have moved inside. The lives and imaginations of many young people are constrained within four walls, tiny gardens and the inside of cars. The concept of “playing out” is becoming a distant memory as is gossip based knowledge of everyone’s name and business on your street.

The true concept of healthy streets starts and ends with residential streets. Most people who work or go to school are guaranteed to leave their house in the morning and return in the evening. These two periods of time are crucial for physical activity. If people enter their cars and strap their children in the back then we lose the chance to administer the miracle drug that could extend their lives by ten years. Residential streets give the first impression as to whether active travel is possible. The choice to walk and cycle or stroll to the bus stop starts at the front door.

If the footway is blocked with parked cars and the side roads are wide and intimidating to cross then the choice to run to the safety of the car becomes a simple and obvious one for people. The instruction from this design guide is simple:

take the design of residential streets seriously. Leicester will not support any design where the needs of residents who choose to walk or ride are marginalised to accommodate the smooth movement of motor traffic. When turning into a residential area, a driver should become instantly aware that this is a slow speed environment where social activity may be taking place even within the carriageway.

Streets should be designed around the needs of the elderly, impaired and young with slow speeds and regular places to sit, rest and socialise. Engineers designing new streets all know the visibility splay of a person in a car but few are aware that the visibility splay of a child is much more narrow than an adult. This makes it very difficult for children to determine approach speeds.

A research paper on this topic found that children cannot perceive approach speeds greater than 20mph. Given that a collision at 40mph will in all probability kill a child, high speeds cannot be tolerated in places where we are encouraging children to find freedom and be active. Walking and riding are pleasant when the design speed is slow and so this enables active travel.

The images on the next page show neighbourhood residential streets in Leicester where social activities could be encouraged through street design choices. By adjusting kerb lines, installing crossings or creating school and play streets activity can return to streets.

The test ground for healthy streets will be the neighbourhood residential streets where small changes can make a big difference to people’s lives. This is the place where lifelong behaviours are learned and where the quality of your life is determined. A civilised society needs civilised streets.

ref 16. Wann et al. (2011). Association for psychological science, <https://journals.sagepub.com/doi/pdf/10.1177/0956797611400917>



Figure 82 Win back space from parking

Space used for parking could be used for street trees, seating or social space. If there is a demand for this activity, then parking relocation should be considered.



Figure 84 Tighten corner radii

The tighter the corner radii, the shorter the crossing, the slower the turning vehicle speed and the less intimidating the street becomes.



Figure 83 Reassign street use

Streets can change their function at different times of the day and some streets lend themselves well to activities involving young people. Reclaim the streets for people.

3.3 WALKING + CYCLING IN HARMONY

This chapter considers the question of allowing cyclists and pedestrians to share space which, in terms of cycle movement, can provide opportunities for more continuous and direct routes and, ultimately, more comprehensive cycle networks.

Permitting cyclists and pedestrians to mix is also more flexible in terms of meeting demand, with certain times of day busier for cyclists than for pedestrians – for instance the morning and evening rush hours – and vice versa at midday when there is more shopping. It is also an arrangement which allows for growth in cycling without the need for, at least, significant changes in infrastructure.

The approach should also be beneficial in terms of streetscape, not only in respect of removing unnecessary traffic management paraphernalia but also by introducing good quality paving and the careful selection and placing of street furniture such as seating and cycle racks, as well as trees.

By arranging these elements in a clear, easily understood and logical way, the resulting street layout can help cyclists and pedestrians to orientate (to improve the 'legibility' of the area) and is particularly helpful for the visually impaired. Furthermore, designing to the pedestrian scale of movement encourages slower, more appropriate, cycling speeds.

Of course, allowing cyclists and pedestrians to share space does require courteous behaviour and it has been noted that, in places where this has been allowed for some time, such behaviour appears to be prevalent. This observation is not made as the result of any objective study but simply from spending time in towns and cities on the Continent and also places in Britain such as Leicester and the London Borough of Kingston where such mixing has long been accepted.

Camillo Sitte, sometimes described as 'the father of modern city planning', was the principal of an art college in Vienna who, by the late 19th century, was becoming very concerned at what he saw

as the trend towards the engineer controlled city, resulting in what he saw as monotony and dreariness in city arrangements – he wrote 'City Planning According to Artistic Principles' (ref 16), published in 1889, in an effort to restore fundamental but forgotten principles in civic design and urban aesthetics.

In the United Kingdom there was no equivalent at the end of the 19th century to the work of Camillo Sitte in influencing the planning of existing cities, although the garden city movement was of major influence throughout the world on new developments.

During the late 1990s and into the new century there has been an increasing emphasis on improving the appearance of streets and public spaces, of humanising them as a catalyst for urban regeneration. In Britain, which traditionally has embraced the widespread use of safety barriers, the past few years has seen the removal of significant amounts of this unattractive feature of many shopping streets and the severing effect it has on the street.

This removal or de-cluttering of the streetscape, the removal of unnecessary traffic management paraphernalia, has sometimes been referred to as 'simplified streetscapes' and covers a range of streetscape treatments, from a traditional carriageway and footways, to a single surface arrangement with the path for motor traffic less clearly defined – an informal street. What they have in common is that they should be the outcome of a process which considers what is the best arrangement for the space in question, and how best to achieve this most simply and elegantly, with the minimum of traffic management features.

To be successful, town and city centres need to be tightly knit, varied, 'legible' (readily understood, particularly important for the visually impaired), and designed to the pedestrian scale of movement. In the broadest sense, cycling shares many of the same objectives as walking

3

(for example, in reducing motor car traffic and providing exercise) and, if provision for cycling is thoughtfully introduced into pedestrian priority areas (if it is not already there in the first place as in many towns and cities in north Europe), it can help achieve the same kind of urban fabric as walking.

Cycling and walking should be mutually supportive, and it is important that the streetscape is arranged for their successful coexistence. An essential requirement is that cycling speeds are restrained in areas shared with pedestrians.

For many cyclists the town or city centre is a destination. With the exception of major hubs such as railway stations where large amounts of cycle parking may be required, the convenience of cycling leads to a need for cycle parking to be distributed throughout the centre. Furthermore, cycle routes passing through the centre are far more attractive and direct than the alternative of a trafficked relief road.

In accommodating cycling, a balance needs to be struck between 'legibility' and the desired speed of the streetscape layout. Having distinct 'paths' and 'nodes' are important in achieving 'legibility'. But, in respect of paths for cyclists, clarity could breed speed as the clearer the definition the higher the speed of some cyclists will be.

For instance, providing a kerb separated cycle track through a pedestrian area could give some cyclists a sense of entitlement to that track and to speeding along it – everyone would lose out, particularly the visually impaired – pedestrians would be less tolerant of cyclists not using the track and slower cyclists would also be intimidated. The kerb would also be an obstruction for wheelchair users wishing to cross the cycle track.

Relatively low cycling speeds in pedestrian areas would also promote passive passing, again less intimidating for slower cyclists and pedestrians – it's not the speed of travel, it's the passing speed that's crucial.

In respect of cycle routes through the centre the starting point should be to make use of any suitable infrastructure that is already in place, to help define its paths and nodes, and the routes through the area. A well-designed pedestrian area should be easy to understand (including for the visually impaired), imply low speed and be logically laid out. For instance, a wider pedestrian street could be single surface with an asymmetric cross-section, with a subtly defined off-set track for service vehicles, perhaps using a drainage channel or the 'corduroy' tactile (warning the visually impaired of a hazard ahead) to define one side and a line of street furniture (benches, cycle parking, bins, trees) the other.

Another example might be a narrower, single surface, street where the track for service vehicles runs down the middle, with drainage channels (and perhaps the 'corduroy' warning tactile as well) defining both sides. In both examples cyclists would usually use the track for service vehicles and pedestrians the retail frontage but crossing the street would be easy.

It might be considered necessary to raise the profile of the paths and nodes through the area to help improve its 'legibility'. For instance, to bring a transition/decision point to the attention of a cyclist or pedestrian – at a junction ('node') for instance – a circular paving layout could be introduced.

Along a path there might be parallel strips of different coloured paving to emphasise movement in that direction, with horizontal strips suggesting slowing down at a node where there is a choice of route, or transition to another cycling regime. Slow and easy transition is less stressful for both cyclists and pedestrians.

There is less need to continually alert cyclists and pedestrians of shared areas in towns and cities where cycling has long been accepted in pedestrian areas, as it is in many continental cities and cities in Britain such as Leicester. Nevertheless, there is

no harm in reminding cyclists and pedestrians of the merits of tolerance, particularly if the message is put across in a friendly way and is not strident – a reference to cyclists being ‘guests’ in an area might be appropriate or alerting all users to the area being shared and to be aware of other users.

Such signage should appear at entry points/gateways to the areas where cycling and walking are mixed, and at junctions where cyclists and pedestrians share the same crossing facilities.

When shared areas are first introduced additional, temporary, signage could be put up for a limited period until the facility has become established, and then removed.

Cycling sits better mixed with motor traffic or in separated space in most street contexts but the area where they come together with pedestrians and need to be harmonious is in, what Sitte would refer to as, the plaza. The history of these public spaces makes them vital to cities as magnets for activity. They create places to view the city and as such should always be prioritised for those with intent to dwell. This chapter argues that the movement of considerate cyclists through and to these spaces can add to the character, if the public space is successfully designed.

In the great plazas of Italy pedestrians do not jump back in alarm at the sight or sound of a passing cyclist. Likewise, a cycle bell ring in a Parisian plaza has an assumed meaning of “vive vital” rather than “get out of my way”. It is assumed in both cases that courtesy will be shown, and conflict avoided. Civilised spaces instill these virtues in all those engaging with the street in an active manner. Cycling will indeed be civilised in civilised spaces, so it is a false assumption that cyclists are immune to virtue and so should be banned. In having adopted a more enlightened approach, Leicester is reaping the behavioural benefits of normalising considerate cycling.

Since neither cyclists nor pedestrians have a windscreen constraining or mechanising their surroundings, these open yet enclosed plazas engage them and if planned well the effect should be harmonious. Leicester has provided its own additional characteristic which the rest of the UK should note: A successful public space allows for the pleasant movement of cyclists. Cyclists are traffic, but they are humane in that they also engage with public space in the way pedestrians do. They have the same visual perspective.

The many ways in which pleasant cycling can be promoted can be summarised as follows:

- Clarity breeds speed
(Open the area and suggest positioning rather than enforcing it with straight white lines)
- Passing should be passive
(All indications of visual priority should be removed as it is not high approach speeds that is anti-social but high passing speeds.)
- Cyclists are guests
(Allow access to all destinations by default rather than segregating with vertical features)
- Design to reduce stress
(Avoid putting objects in the place of cyclists or awkward transitions)

In conclusion, cycling in public spaces should not be alarming and harmonious walking and cycling should not be remarkable. If public spaces are designed well, they can benefit from the unique attributes of both pedestrians and cyclists. When walking and cycling are united together the image of the city prospers.

ref 17. Sitte, Camillo (1889) ‘City Building According to its Artistic Fundamentals’, Vienna (Translated into English by Charles T. Stewart (1945) as ‘The Art of Building Cities’, New York, Reinhold Publishing Corporation)

3.4 DEVELOPMENT + GROWTH

Leicester is in the process of preparing a new Local Plan which sets out its vision and objectives for the growth of the city during the period up to 2036. The new Leicester Local Plan will replace the existing core strategy (2014) and the saved policies from the 2006 Local Plan.

3

The new Local Plan will describe how the council will respond to local priorities and how it will meet the social, economic and environmental challenges and opportunities that face the city. It will identify broad locations of, scale and type of development and supporting infrastructure that will be required.

The population of Leicester is growing fast – recent government projections show that the city’s population will increase by almost 14% between 2016 and 2036, to around 400,000 people. The population of Leicester and Leicestershire as a whole is projected to increase to over 1.1 million in the same period, an 11% increase.

This forecast increase in population, together with an increase in the number of single person households, are key inputs into a formula that calculates that around 29,000 additional dwellings would need to be provided in the city between 2019 and 2036 to fully meet housing needs with further substantial housing development just outside the city boundary.

Leicester’s city centre is the focus for commerce, retailing, culture, leisure and entertainment for the city and county. A vibrant and thriving city centre is essential for growth in the city’s economy and is at the heart of the greater Leicester and Leicestershire. Over £1 billion of investment in iconic new developments such as Highcross, Curve Theatre, Phoenix Square, Market Food Hall and extensive public realm improvements continue to transform the city, but there is still more to do.

Much of the development activity needed to enable restructuring of the economy will occur in the area within and around the city centre in the Central Development Area (CDA). The city council

will be encouraging investment in the CDA to maximise its potential for regeneration.

The CDA will be a focus for employment development, specifically offices, and will also be a location for major housing growth. Around 23% of the planned housing provision for the city will take place in the CDA. In addition, the CDA contains the city’s primary shopping area, where significant growth in retail floorspace is planned.

The emerging design principles for these Character Areas will take into account the guidance contained in this Street Design Guide, particularly the need to improve access and connectivity for pedestrians, cyclists and public transport.

The Design Council and Sport England’s active by design work are also key reference documents:

ref 18. <https://www.designcouncil.org.uk/resources/guide/active-design-designing-places-healthy-lives> or sport England’s active design guidelines

ref 19. <https://www.sportengland.org/media/3964/spe003-active-design-published-october-2015-high-quality-for-web-2.pdf>

For the avoidance of doubt, the design of cycling and walking infrastructure on all new and modified highways serving new development and re-developed areas will follow the design principles set out in this guidance.

Although Leicestershire County Council is the highway authority for the urban extensions just beyond the city boundary, the City Council will seek to influence the provision of cycling and walking infrastructure for these developments so that it also accords with this document.



4. Streets in New Developments

4.1 PROCESS + DESIGN PRINCIPLES

APPLICATION OF THIS SECTION

This section of the Leicester Street Design Guide applies to new streets that are delivered through new residential and other types of developments, normally by developers or other organisations outside the City Council.

4

The new streets will normally be designed by developers and/or their advisers and the City Council will act in the role of approving authority using its statutory planning, highways and drainage powers.

STRUCTURE OF THIS SECTION

Following this introduction the process is shown that the City Council will expect to follow in its dealings with developers and their advisers throughout the Concept Design (pre-planning), Developed Design (planning application) and Detailed Design (highway adoption) stages.

Figure 85 summarises these stages and the information required by the City Council at each stage and sets out the key design principles that the City Council will apply to the design of movement networks and individual streets to ensure that the high level principles contained in Section 1 of this document are met.



STREET DESIGN PROCESS - NEW DEVELOPMENTS

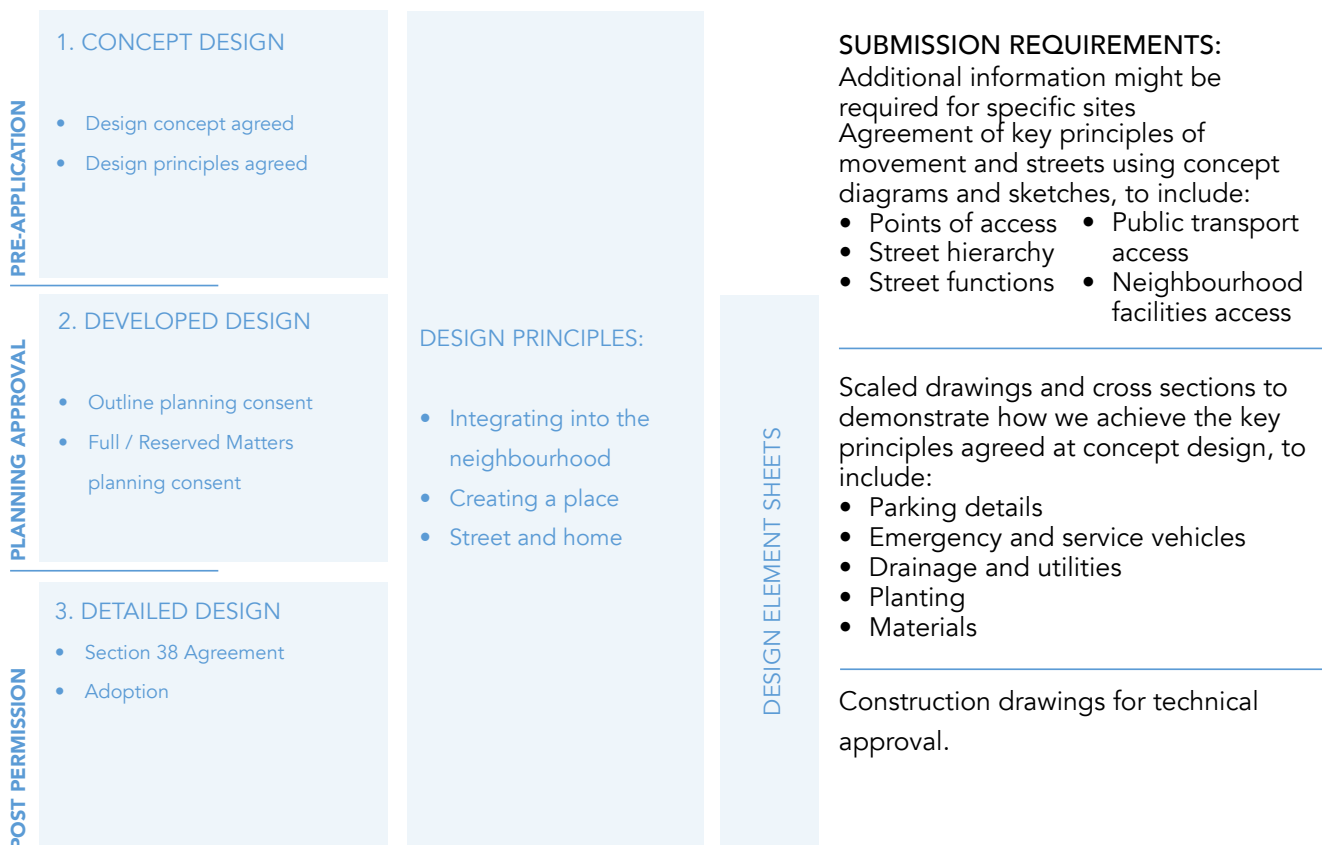

Figure 85 Summary of Process, Design Principles and Submission Requirements for Streets in New Developments

This process is partly based on Building for Life 12 (BfL12) which sets out a series of questions and prompts to assist applicants and designers to create good places. The City Council will make use of BfL12 when considering developers’ proposals. BfL12 is referred to in the ‘Achieving Well-Designed Places’ section of the Draft Leicester City Local Plan.

Following this part of the Street Design Guide a set of Design Element Sheets gives detailed technical guidance and requirements for individual components of streets, including carriageways, footways, cycle infrastructure and drainage features.

The purpose of this part of the guide is to inform applicants how to assemble these components to create new streets that meet the overall requirements of the City Council to create successful places.

DESIGN AND APPROVAL PROCESS - OVERVIEW

Process and Gateways

This part sets out the process by which streets in new developments will be assessed.

In most cases streets in new developments will be planned and designed by developers or other external organisations and the City Council will need to grant planning consent as the Local Planning Authority. The City Council as Local Highway Authority will be a consultee at this stage. Post-planning approval the Local Highway Authority will take responsibility for the approval of all new adopted highways, normally through the process set out in Section 38 of the Highways Act 1980.

Applicants will be required to work through this process via a series of gateways, as shown on Figure 89. This process extends from the initial concept of the development, at the pre-application stage, through to the post-permission Technical Approval and Adoption stages.

Applicants will normally be required to gain approval at each gateway before passing through to the next stage.

During the pre-application stage, the City Council will wish to agree the Concept Design for the new development, including its overall movement framework and street hierarchy, before more detailed street layout and design proposals are presented for agreement at the Developed Design stage.



Figure 86 Designing for slow speeds at Ashton Green, Leicester



Figure 87 Enhancing character at Sock Island, Leicester



Figure 88 Creating a place at Wheatsheaf Works, Leicester

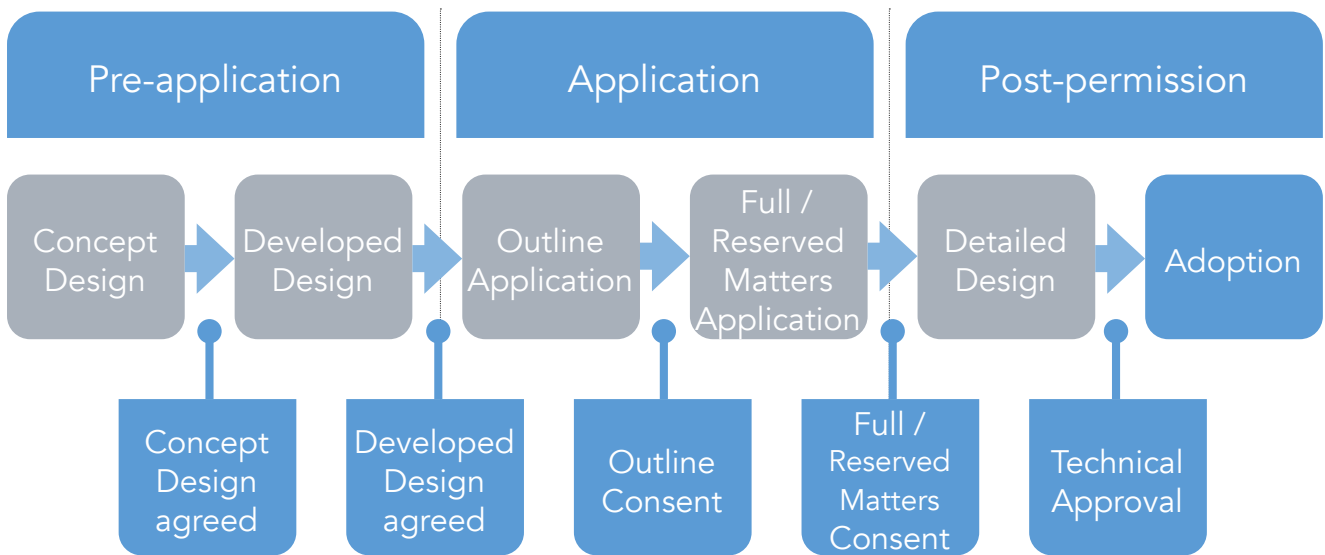

- Concept Design Checklist**
- ✓ Site location plan and size and mix of development
 - Initial analysis of the opportunities and constraints of the site, considering existing movement patterns of the site and its surroundings and how the development can best respond to them.
 - ✓ Simple concept sketches/ plans showing how this initial analysis influences:
 - Points of access
 - Proposed street hierarchy
 - Proposed street functions
 - Walking, cycling and public transport access
 - Key nodes and spaces
 - Waste management strategy

- Developed Design Checklist**
- ✓ Scaled drawings and cross sections to demonstrate how we achieve the key principles agreed at concept design, to include:
 - Site access proposals
 - Walking and cycling routes
 - Public transport routes and stops
 - Street hierarchy and typologies
 - Typical junction details
 - Car and cycle parking standards and typical arrangements
 - Drainage and utilities principles
 - Planting
 - Materials

- Detailed Design Checklist**
- The following standard checklist of information needs to be provided for technical approval as checking will only commence once all information has been received, including:
- ✓
 - Horizontal alignment
 - Vertical alignment
 - Standard details
 - Ground conditions
 - Drainage and utilities
 - Planting
 - Street lighting

Figure 89 Design and Approval Process and Gateways



Figure 90 Direct access to homes fronting a main street at Ashton Green, Leicester

Design Policies in the Local Plan are available on Leicester City Council website - www.leicester.gov.uk

Coordinated Decision-Making

All development proposals will be considered by the different sections and departments of the City Council in a coordinated way, following the 'Development Team' principles set out in Manual for Streets.

Figure 91 shows how the Planning, Urban Design, Highways Development Management, Lead Flood Authority and Highways Agreement teams within the City Council will interact with the developer's design team through the various stages.

Other City Council departments, e.g. Waste Management, may need to be involved on particular issues depending on the nature of the site and development. Developers must agree their proposals with all sections of the City Council

at each gateway stage to ensure a design is achieved which best meets all of the authority's requirements.

Developers are encouraged to obtain the agreement of the Local Highway Authority to the design principles for new streets during the pre-application stage to minimise the time taken for approval once the planning application has been lodged.

Although applications for outline consent may reserve details of the on-site highways for future determination, the City Council will normally wish to approve an overall masterplan for the site at this stage, and this will require the design of all new streets to be developed to a high degree of certainty.

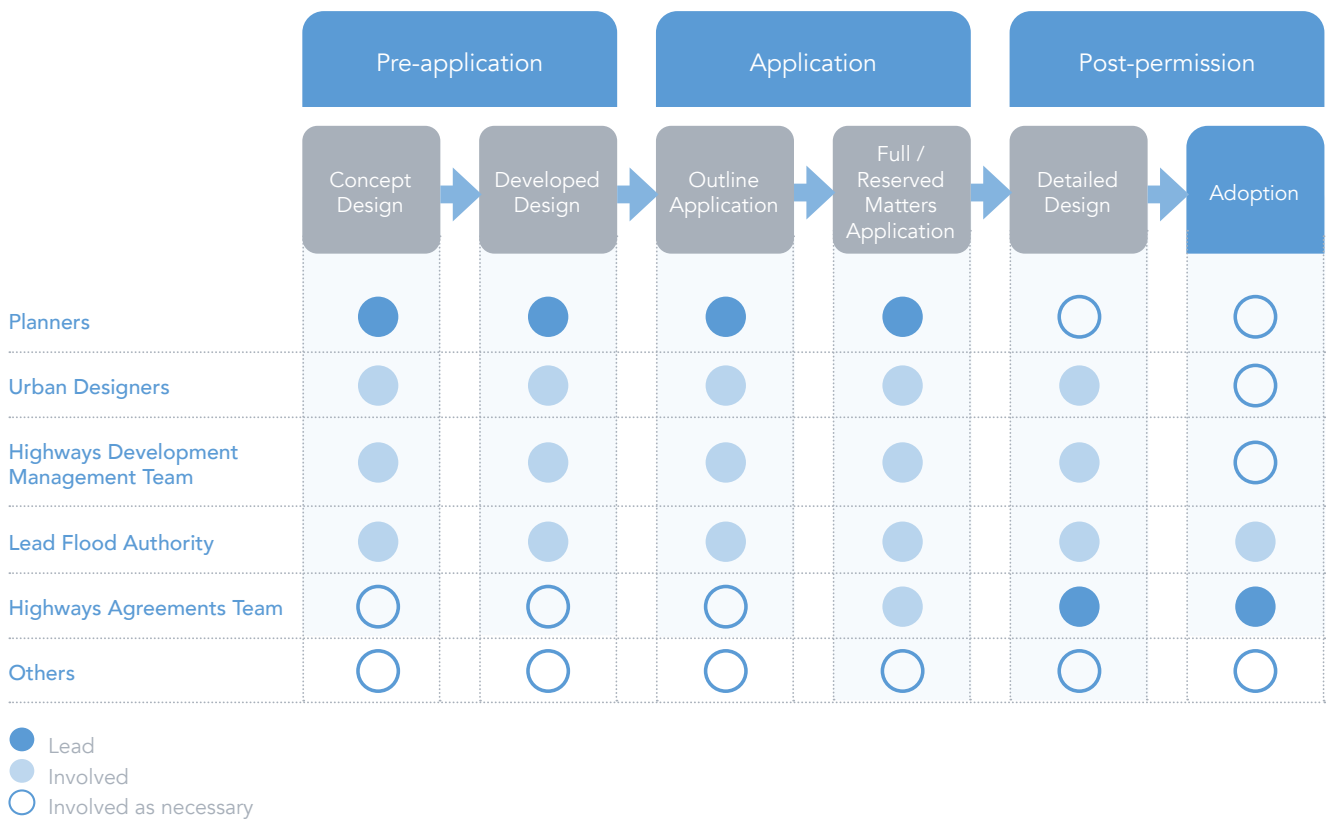

Figure 91 Coordinated Decision-Making

It may be necessary for the Highways Agreement section of the City Council to be involved pre-planning when there is any issue that may relate to the ability of the Highway Authority to give technical approval to adoptable streets.

INFORMATION REQUIREMENTS

Concept Design

At the concept design stage, the prospective applicant will be required to provide concept diagrams and sketches setting out an 'initial vision' for the access and movement strategy for the site, both internally and externally, using the Concept Design Checklist

This will need to cover all modes of transport but with particular emphasis on walking, cycling and public transport, and be integrated with initial concepts for land use, building forms and key spaces within the site.

Important Building for Life 12 questions to be addressed at this stage will include:

- Connections
- Facilities and Services
- Public Transport

4

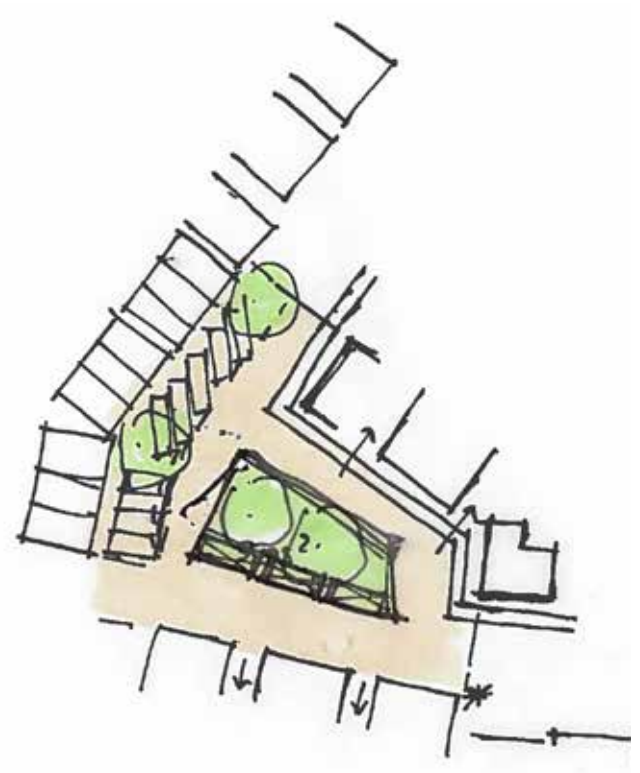

Figure 92 Example of a concept sketch, Blackbird Road

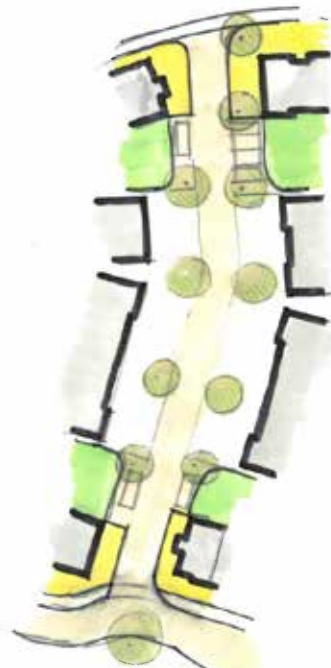

Figure 93 Example of concept sketch

Developed Design

Having identified opportunities and agreed the principles of the movement framework, applicants can then move forward with confidence and begin to add detail to the design.

This will involve the development of a street hierarchy which defines the functions of the various streets - for example which will need to carry buses, which will be the main cycling routes, which will function as important public spaces and which will provide corridors for bio-diversity and/or drainage.

These movement and place requirements will then inform the street typologies which will be built up from individual design elements such as footways, cycle tracks, verges, drainage features and carriageways.

In addition to those highlighted at Concept Design stage, important Building for Life 12 questions at the Development Design stage will include:

- Character
- Creating well designed streets and spaces
- Easy to find your way around
- Streets for all
- Car parking

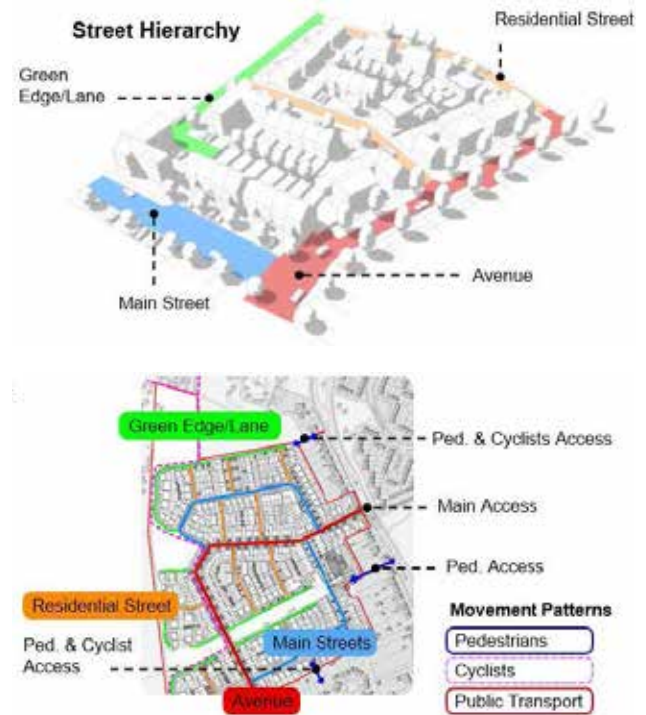

Figure 94 Examples of typical diagrams for Developed Design stage



Figure 95 Example of cross-section information suitable for Developed Design Stage

Planning Application

The level of detail presented for agreement at the Developed Design stage will often be appropriate for a planning application submission, depending on whether outline or full consent is being sought.

In addition, the applicant will need to submit final technical reports relating to highways and other technical matters, which will normally include a Transport Statement / Assessment and Travel Plan.

Planning Validation Checklist

Leicester City Council's validation list sets out the minimum information that is necessary for particular types of application and is designed to ensure that applications can be processed as efficiently as possible.

The list is available at:

<https://www.leicester.gov.uk/media/177947/local-validation-list-2018.pdf>

The list is updated from time to time, or subject to ongoing review, and therefore should be referred to prior to every planning application submission.

The validation list sets out the council's minimum requirements but most applications will require additional information. This may include, for example, scoping for the Transport Assessment and site specific plans. During pre-application the documents and additional information required will be agreed.

KEY DESIGN PRINCIPLES

This part sets out the key design principles for streets on new developments.

It will need to be read in conjunction with the Design Element Sheets, which provide detailed guidance on the various items making up streets. Delivering streets with a strong sense of place that function well in all aspects is crucial to the success of new developments and their integration into the wider City.

General guidance on the planning and design of streets and accesses for new developments, particularly residential development, is given in the source documents:

- Leicester Street Design Guide
- Manual for Streets
- Manual for Streets 2
- Building for Life 12
- Well Managed Highway Infrastructure – A Code of Practice

As shown in Figure 97, the Key Design Principles have been grouped under the three scales of design development used in Building for Life 12, which start with the connections to a development, then consider the place as a whole, and finally the details of the streets themselves:

- Integrating into the neighbourhood
- Creating a place
- Street and home



Figure 97 Key Design Principles for New Streets, based on Building for Life 12

Design Principle:**Integrating Into the Neighbourhood**

Sub Principle:

Key Principles

It is important that new developments are well integrated into their existing surroundings so they form an accessible part of the city rather than being seen as a separate place. This first section of Building for Life 12 provides overall guidance about how successful connections should be made.

4



Figure 98 Masterplan - Poundbury, Dorset



Figure 99 Aerial photograph - Poundbury, Dorset

Things to consider

- ✓ Does the scheme integrate into its surroundings by reinforcing existing connections and creating new ones, while also respecting existing buildings and land uses around the development site?
- ✓ Does the development provide (or is it close to) community facilities, such as shops, schools, workplaces, parks, play areas, pubs or cafés?
- ✓ Does the scheme have good access to public transport and good walking and cycling routes to help reduce car dependency?

Design Principle:

Sub Principle:

BfL12 reference:

Integrating Into the Neighbourhood

Create Well Connected Developments



1a, 1b, 1c, 1d

New developments should be well connected into the existing surrounding neighbourhood by a choice of routes rather than creating an inward-looking cul-de-sac layouts.

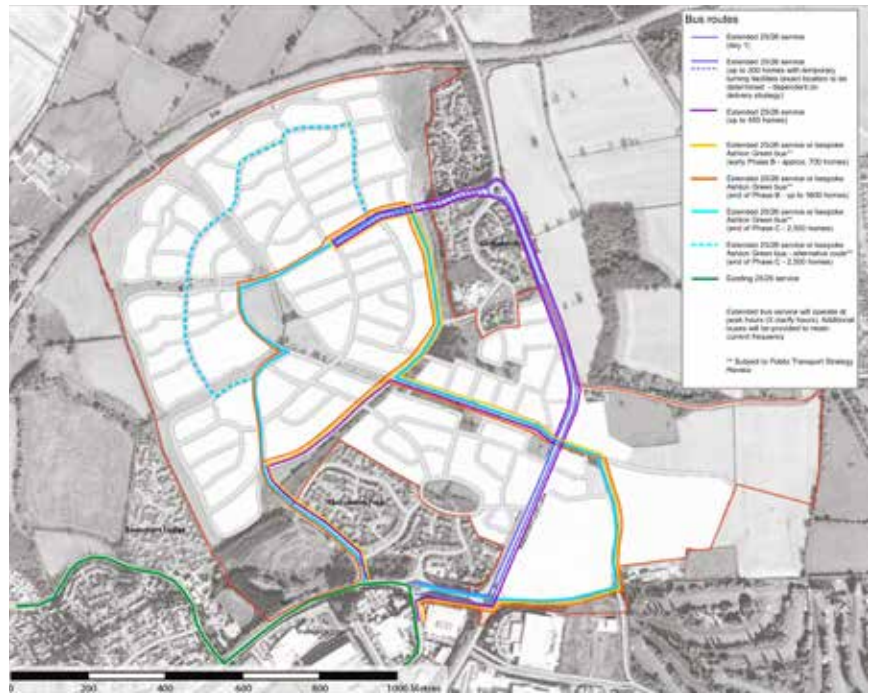

Figure 100 Proposed public transport routes - Ashton Green, Leicester

Design Principle:

Integrating Into the Neighbourhood

Sub Principle:

Provide sustainable transport connections beyond the site

BfL12 reference:



3a, 3b

Developments should enable people to walk, cycle and use public transport to reach facilities well beyond the site boundary. This may require providing or contributing to off-site improvements, particularly for walking and cycling.



Figure 101 Walking and cycling connectivity – Ashton Green, Leicester

Design Principle:

Integrating Into the Neighbourhood

Sub Principle:

Structuring the Layout

BfL12 reference:



1a, 2c, 2d

Developments should be seen as an opportunity to create new routes through the site linking new, existing and potential future places, particularly for sustainable modes of transport.

Clear and legible routes into and through a development will normally be major structuring elements in a layout, and places where routes meet and cross provide good opportunities to locate everyday facilities and opportunities for people to gather.

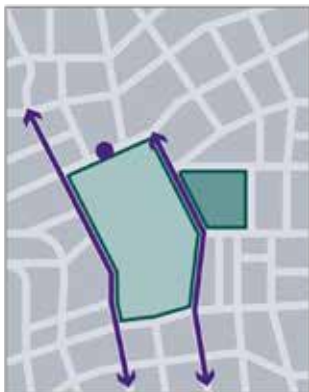

Consider how best the site can be connected with main routes and public transport facilities



The typical cul-de-sac response creates an introverted layout which fails to integrate with its surroundings



A more pedestrian friendly approach that integrates with the surrounding community. It links existing and proposed streets and provides direct routes to bus stops.

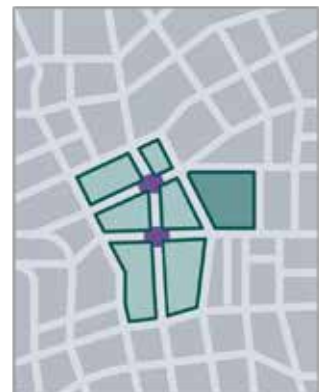

This street pattern then forms the basis for perimeter blocks which ensure that buildings contribute positively to the public realm, and with opportunities for creating significant places where routes meet.

Figure 102 Integrating new developments into the existing urban fabric is essential (source: The Urban Design Compendium)

Design Principle:

Integrating Into the Neighbourhood

Sub Principle:

Planning for Sustainable Modes

BfL12 reference:

 1b, 2c, 2d, 3a, 3b

It may be appropriate to provide fewer accesses and routes for private cars to give priority to sustainable modes of transport, using the principle of filtered permeability.

Good access from all new dwellings by public transport is important, aiming for a maximum walk distance to bus stops of 250m; however a balance may need to be struck between the directness and viability of bus routes and maximum walk distance from dwellings to bus stops.

Public transport stops should be in well-used places, ensuring they are accessible for all.

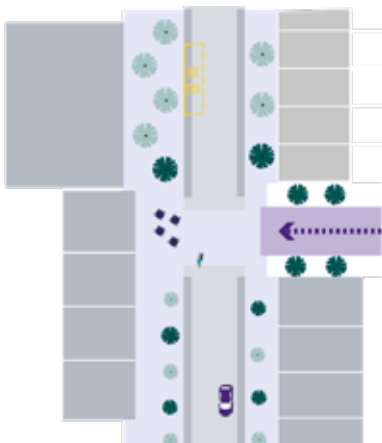

Filtered permeability delivered by key traffic free route



Figure 103 Filtered permeability for pedestrians and cyclists

Design Principle:

Integrating Into the Neighbourhood

Sub Principle:

Planning for future connectivity

BfL12 reference:



The limits of adoption of new streets should extend to the edge of the developer's landholding to avoid creating ransom strips, which make it difficult to achieve well-connected layouts on potential adjacent sites.

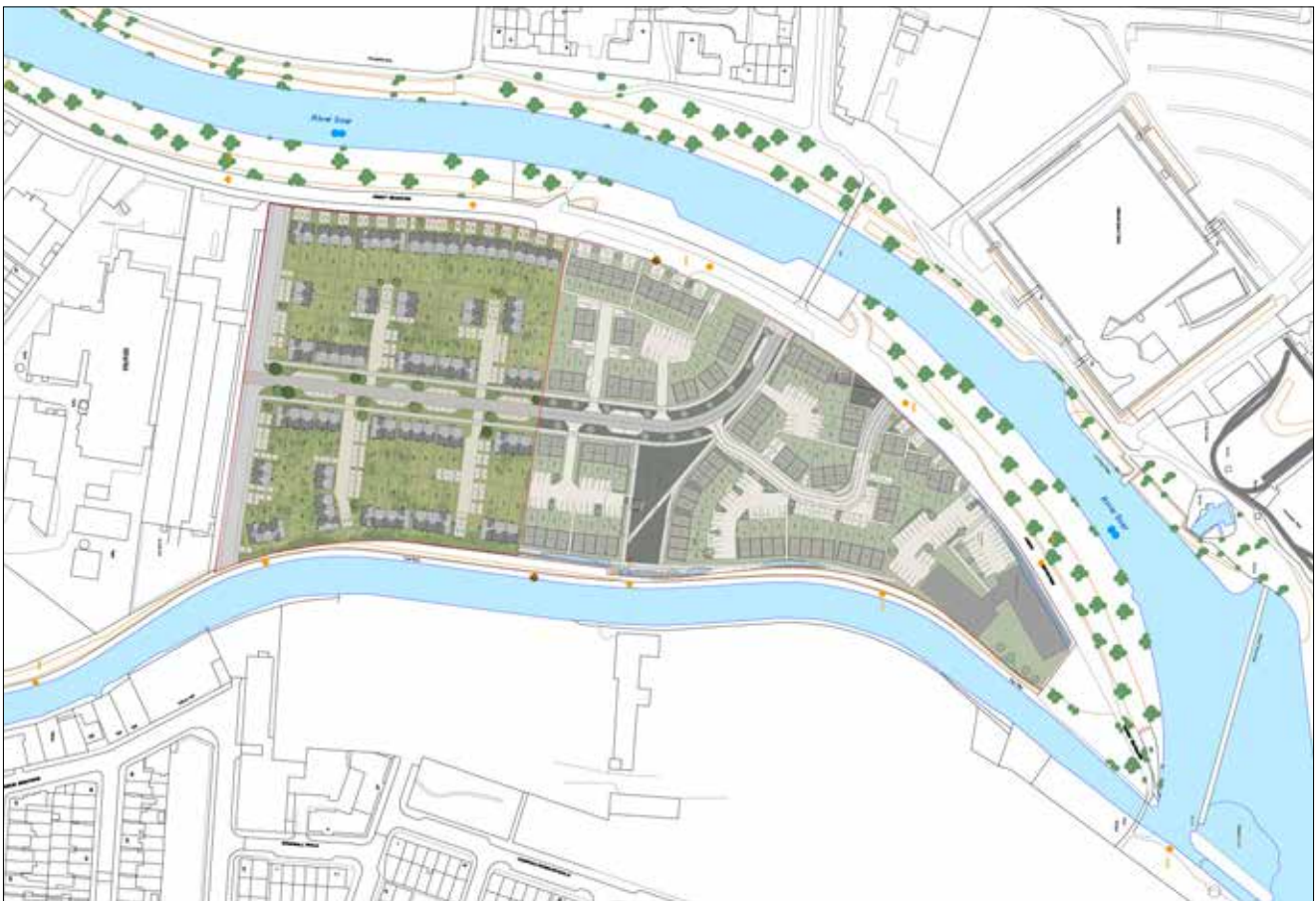

Figure 104 Planning for future connectivity at Abbey Meadows

Design Principle:

Sub Principle:

BfL12 reference:

Creating a Place

Key Principles



Questions 5-8

Placemaking - strengthening the connection between people and the environments they live in and use - contributes to people's health, happiness, and wellbeing. Manual for Streets emphasises the contribution that well-designed streets make to achieving good places.

Creating a place requires consideration to be given to local character, working with the site and its context, designing well defined streets and spaces that are easy to find your way around. The following section provides overall guidance and key recommendations based on the second section of Building for Life 12.



Figure 105 Dickens Heath local centre, Solihull



Figure 106 Local centre, Poundbury, Dorset

Things to consider

- ✓ Are buildings designed and positioned with landscaping to define and enhance streets and spaces and are buildings designed to turn street corners well?
- ✓ Is the development designed to make it easy to find your way around?

Design Principle:

Creating a Place

Sub Principle:

Create well defined streets and spaces

BfL12 reference:



Layouts should provide a legible network of adopted streets, routes and spaces, well connected externally as well as internally, particularly for sustainable modes. Cul-de-sacs, and particularly unadopted private driveways, disrupt movement patterns and are not to be used unless there is no practical alternative.

Streets should either be straight or gently winding, defined to suit the position of buildings and with uncomplicated junctions and squares with memorable features that enable people to find their way around easily.

Street and building design should be considered together so that an understandable hierarchy of streets is created. On larger sites a variation in street typologies should be used with different widths and street enclosure, keeping to well-proportioned height to width ratios, as well as using elements such as street trees where appropriate.

Streets should provide direct frontage access to the buildings and public realm immediately alongside them. This principle also applies to existing streets that border developments. This helps to promote social interaction, minimise opportunities for crime, calm traffic speeds and achieve better integration between the street and its environment.

	Minimum	Maximum
Minor streets, e.g mews	1:1.15	1:1
Typical streets	1:3	1:1.5
Squares	1:6	1:4

Source: Manual for Streets (2007) p.54



Figure 107 Well defined street at Wheatsheaf works, Leicester



Figure 108 Direct frontage access at Ashton Green, Leicester

Design Principle:

Creating a Place

Sub Principle:

Create distinctive streets and spaces

BfL12 reference:



At key locations within the street network it may be appropriate to use higher quality materials, planting and street furniture to enhance the street and add character, drawing on local context. These should be discussed and agreed with the Local Highway Authority at the Developed Design Stage, including the possible application of commuted sums.

Drainage, and particularly sustainable drainage systems should be considered in conjunction with the design of the street layout, looking for opportunities for integration. Swales and rain gardens can form attractive as well as functional elements within streets, adding character by creating interesting streets that can enhance bio-diversity.

Leicester City Council’s Technical Guide ‘Sustainable Drainage Systems (SuDS) contains more detailed information relating to the use of SuDS in the City, including clarification on what LCC will adopt or not adopt.

All SuDS should be designed in accordance with the DEFRA non-statutory technical standards for sustainable drainage systems and the CIRIA SuDS manual (C753) 2015.

In the event SuDS are not used within a development, evidence will be required to show that complying with the national standards for SuDS, set by DEFRA, would not be technically feasible.



Figure 109 Swale adjacent to the footway at Sock Island, Leicester



Figure 110 SuDS pond at Ashton Green, Leicester

Design Principle:

Creating a Place

Sub Principle:

Create Legible Networks

BfL12 reference:



At the Concept Design stage it is important that a logical hierarchy of streets is developed and agreed with the City Council. As the design progresses streets and spaces should be well defined by buildings to help aid legibility and wayfinding. For example a tree lined avenue through a development can be an easy and effective way to help people find their way around.



Figure 111 A legible network of routes at Waterside, Leicester

Off-highway cycle and pedestrian routes through green spaces can also form a key part of the movement network for active travel. They should be lit and direct so they are usable at all times of the day and year. Where possible pedestrians and cyclists should be provided with separate facilities so that each type of user can move at their desired speed in comfort.

A connected network of cycle routes should be provided which serve all parts of new developments and lead directly to off-site routes. Main streets, including bus routes, should provide protected cycle tracks, separate from the footway, which have priority over side roads. Shared use footways will not be acceptable on new developments.



Figure 112 Off highway cycle and pedestrian route



Figure 114 Cycle superhighway, CS2, London



Figure 113 Off-carriageway one-way cycle track through new development, Cambridge



Figure 115 Secure cycle parking is needed in all types of development

Design Principle:

Sub Principle:

BfL12 reference:

Street and Home

Key Principles



Questions 9-12

It is important that new developments create streets that can be used by all people, successfully integrating car and cycle parking, clearly defined public and private spaces and well-designed external storage and amenity space.

The following section provides overall guidance and key recommendations based on the third and final section of Building for Life 12.



Figure 116 Well designed integrated bin storage



Figure 117 Poorly thought-out design leading to clutter

Things to consider

- ✓ Are streets pedestrian and cycle friendly and are they designed to encourage cars to be driven slower and more carefully?
- ✓ Are streets designed in a way that they can be used as social spaces, such as places for children to play safely or for neighbours to converse?
- ✓ Is there enough car and cycle parking for residents and visitors and is it convenient to people's homes?
- ✓ Are any parking courtyards small in size and are they well overlooked by neighbouring properties?
- ✓ Are garages well positioned so that they do not dominate the street scene?
- ✓ Are streets and homes designed to deliver the agreed waste management strategy and so that they don't dominate the street scene?

Design Principle:

Street and Home

Sub Principle:

Street Types

BfL12 reference:



Street types should not be standardised but should be built up from a series of components (footway, cycle track, street trees, verge, swale, carriageway etc) to suit its position in the hierarchy.

Guidance on the design of these individual elements is given in the Design Element Sheets.

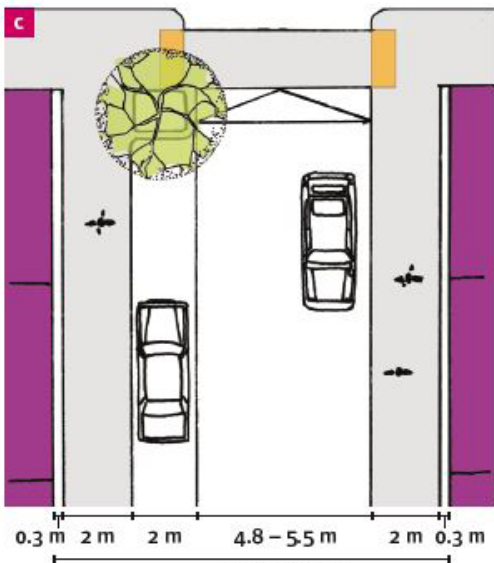

Figure 118 Typical representation of a street character type (MfS extract)



Figure 119 Typical street cross sections - Waterside, Leicester

Streets are defined as 'conventional' if they include a footway. Single surface streets without footways may be used where the maximum motor vehicle flow is low and should primarily be designed as social and play spaces (Home Zones) which occasional motor vehicles can use to access dwellings.



Figure 120 Home Zone in South Lynn Millennium Village



Figure 122 Single surface street at Ashton Green, Leicester



Figure 121 Home Zone in Castle Vale, Birmingham



Figure 123 Single surface street in Newhall, Harlow

Design Principle:

Street and Home

Sub Principle:

Design Speed

BfL12 reference:



9a, 9b

Streets in residential areas should be designed so that vehicle speeds do not exceed 20mph, and this should be achieved through the geometry and layout of the development rather than through overly-engineered traffic calming



Figure 124 Trees planted in the highway at Ashton Green, Leicester, help to reduce vehicle speeds

Design Principle:**Street and Home**

Sub Principle:

Street Geometry

BfL12 reference:



9a, 9b

The geometry of carriageways and vehicle track spaces, including centreline and corner radii, should be as tight as possible to limit traffic speeds. Track testing of layouts will normally be required. Excessive forward visibility on bends and curves should not be provided. Trees and planting may be used to limit forward visibility where necessary.

4



Figure 125 Reduced forward visibility on street in Lount, Leicester helps to reduce vehicle speeds

Design Principle:

Street and Home

Sub Principle:

Continuous Footways

BfL12 reference:



9a, 9b

Continuous footways should be taken across private accesses and the mouths of minor road junctions to slow traffic at this potential conflict point and give effective priority to pedestrians.



Figure 126 Continuous footways should be used



Figure 127 Continuous footways in Clapham Old Town, London



Figure 128 Continuous footways in Waltham Forest, London

Design Principle:**Street and Home**

Sub Principle:

Well-designed car parking and other details

BfL12 reference:



10a, 10b, 10c, 10d

Well-designed car parking is important to the success of any residential development. This should match the overall supply and distribution of car parking across the site to forecast demand, taking into account the accessibility and location of the site,

On-street car parking is legible and efficient. Wherever on-street car parking is anticipated clear and dedicated space should be provided for it to prevent parking on footways. Street trees and planting should be used to balance the visual impact of parked cars. Allocated parking is not permitted within the adopted Highway.

4

Rear car parking courts are not favoured as they are unpopular with residents, lead to excessive on-street parking and are wasteful in terms of land take.

Streets, including elements such as street lighting should generally be constructed from a simple palette of standard materials and equipment, although special items can be considered at important locations to add special character. Wall-mounted lighting on buildings will be considered. Non-standard materials and equipment may be subject to a commuted sum.

Waste collection is an important consideration for the design of streets and networks. A connected network of streets will reduce the need for refuse vehicles to turn and reverse.



Figure 129 Well considered on street parking interspersed with landscaping and bin storage areas

4.2 DESIGN ELEMENT SHEETS

PURPOSE

This section provides a suite of Design Element Sheets that illustrate how the principles of the Leicester Street Design Guide (LSDG) can be executed in layouts of new developments and improvements to existing highways.

VALIDITY

4

The contents of the Design Element Sheets shall supersede 6Cs design guidance within the City of Leicester as of May 2020. The 6Cs design guidance is therefore withdrawn in Leicester from May 2020.

The principles of the LSDG shall apply to all streets and highways in Leicester, except where discussed and agreed with Highways Development Control at the outset of the development conceptual design process.

LIST OF DESIGN ELEMENT SHEETS

- 1.Highway Edges and Boundary Treatments
- 2.Public Art
- 3.Footways and Footpaths, and Access for Pedestrians
- 4.Cycle Streets and Space for Cycling
- 5.Bus Infrastructure
- 6.Carriageways and Vehicle Track Space
- 7.Shared Surfaces
- 8.Pedestrian and Cycle Crossings
- 9.Junctions: Priority, Unmarked and Informal Junctions
- 10.Junctions: Roundabouts
- 11.Junctions: Traffic Signals
- 12.Signs, Markings and Traffic Regulations
- 13.Highway Structures
- 14.Cycle Parking
- 15.Motorcycle Parking
- 16.Private Accesses, and Off-Street Vehicle Parking and Servicing
- 17.On-Street Vehicle Parking and Servicing
- 18.Drainage
- 19.Utilities
- 20.Street Lighting

HIGHWAYS TECHNICAL APPROVAL PROCESS

Where a development is likely to require highway to adopted (under a Section 38 Agreement) or for existing highway to be modified (under a Section 278 Agreement) this should be raised as part of pre-application discussions to minimise any lag between Planning approval and Highways technical approval.

The developer should remain in discussion with Leicester City Council Highways Development Control throughout the planning process to ensure any necessary Section 38 and Section 278 agreements are achievable and meet the requirements of this Guide.

BIBLIOGRAPHY

The advice in this guide draws from the principles of the following documents, which should be consulted in the event of a designer requiring further context or background information:

- Manual for Streets
- Manual for Streets 2
- Design Manual for Roads and Bridges
- LTN 1/20 Cycling Infrastructure Design (in draft)
- CD 195 Designing for Cycle Traffic, Highways England
- Transport for London Streets Toolkit, including:
 - London Cycling Design Standards
 - Urban Motorcycle Design Handbook

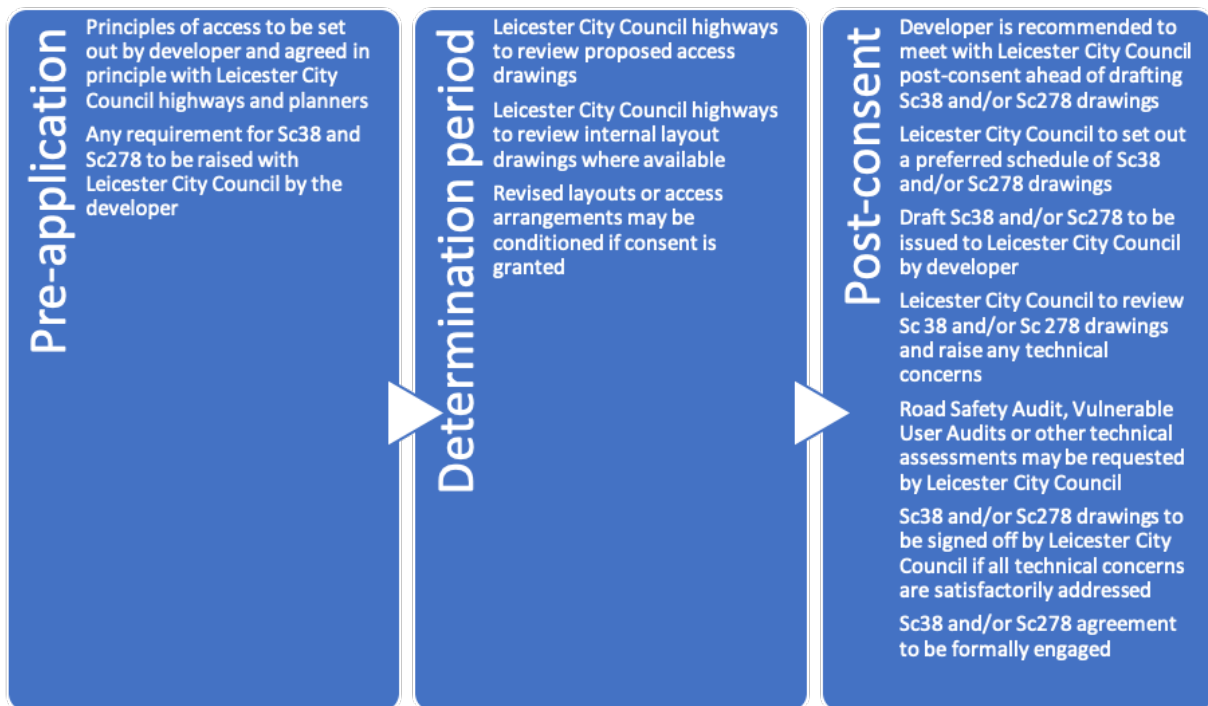

KEY CONTACTS

Queries should be raised with Leicester City Council Highways Development Control via highwaysdc@leicester.gov.uk

DES 01

Highway Edges and Boundary Treatments



DESIGN ELEMENT SHEET

DES: 01

Subject: Highway Edges and Boundary Treatments

Date:	17-05-2019	Version:	0.2
Author:	ANS	Approved:	BD

DESIGN CONSIDERATIONS

4

1. Transitions from areas of public to private realm must be clear and unambiguous to help define the ownership of different parts of the street. This is normally achieved by installing some form of boundary treatment which can also aid streetscape, legibility and navigation for partially sighted people.
2. Wherever the extent of the adoptable highway is not clear e.g. there is no wall, fence or footway edge, an agreed form of boundary marker shall normally be installed.
3. It is just as important to make clear the difference between component parts of the highway, i.e. footway, cycleway, carriageway, verge, parking, etc., as this ensures streets are legible to all users and that each part of the highway can function as intended.
4. The default means of defining highway edges and boundaries between different parts of the highway shall be a kerb, channel or edging.
5. Kerbs and edgings help define and emphasise spaces and provide a clear definition between the footway and carriageway. Kerbs are a mechanism to deter vehicular use of the footway or cycleway. Kerbs and channels also act a drainage conduits.
6. The type of kerb used, both in terms of height and material, can play an important role in informing street character.
7. Kerb design considerations include:
 - Kerbs forming the boundary between the footway and the carriageway shall have a minimum face height of 60mm.
 - In pedestrian-priority areas and with agreement with the highway authority the kerb face can be reduced to a minimum of 50mm, the minimum height detectable by unsighted cane users.
 - Flush kerbs with accompanying tactile paving are required at carriageway crossing points and raised tables to cater for the needs of wheelchair users and other mobility-impaired people.
8. Satisfactory drainage should be provided where kerbs are installed.
9. In addition to a kerb line, the use of verges or trees or both to mark or accentuate boundaries – either external or internal – can add to the attractiveness and utility of a street, consistent with Leicester’s “Healthy Streets” principles.
10. Where provided, trees should normally be wholly within the highway boundary to



The kerb on this street helps accentuate different functions of the street.

DES 01

Highway Edges and Boundary Treatments

ensure they can be properly maintained. This precludes the encroachment of private trees into visibility splays.

11. Existing street trees within developments should be retained wherever possible. Trees that are removed must be compensated for elsewhere in the development.



Trees and other planting have a positive impact on street aesthetic. (Image Courtesy of Jeremy Barrell, TDAG)



New trees should be well integrated and in proportion to the scale of development, increasing the user perception of movement by lining carriageways. Wide footways and verges have the potential to encourage active travel and social interaction.

12. Where existing trees are to be retained, Tree Preservation Orders (TPOs) will normally be

made when outline consent is granted. TPOs are not normally applied to street trees as they are deemed to be in good care.

13. The role of trees and their means of incorporation within new development is to be considered at the concept development stage. Trees shall be planted appropriately in areas where they can succeed to minimise the future maintenance burden on local authorities.
14. Trees shall not exclude buildings and areas of car parking from enjoying good natural observation from the street. Trees can form an important and sustainable component of the drainage strategy.



The retention of these three existing trees within this development complements the green space upon which they lie. They also provide a habitat for birdlife and insects and a suitable resting place for lunchtime picnickers.

15. Tree location and selection shall be coordinated with street lighting positioning to ensure that the latter is able to function appropriately. Spacing and separation are directly related to species.
16. Large trees can provide impressive street features and can aid the legibility of a development. Trees can have a screening role in development, protecting properties from undesirable views or noise, while they can also provide shelter from sunlight, wind and

DES 01

Highway Edges and Boundary Treatments

precipitation.



Retaining large mature trees adds substantially to the quality of a new development.

17. The use of proprietary tree pit systems in new schemes in the city would avoid the problem of pavements lifting over time.
18. The choice of appropriate tree species, in consultation with the City's Trees and Woodlands section, should help guarantee longevity of street trees. Using a variety of different tree species can benefit resilience and the diversity of the wider tree population. The specification of species shall be agreed with the Local Authority during pre-application discussions.
19. Grassed verges have aesthetic value with or without tree planting. They enhance drainage capability and benefit pedestrians' and cyclists' subjective experience of a safe environment. There is a preference for retaining existing grassed verges within developments and the following matters shall be taken into account:
 - Generally, grassed verges, as well as embankments and other areas of open space forming part of the adoptable highway, shall be laid out as amenity grass unless some other form of landscaping is proposed to help enhance the quality and appearance of the scheme.
 - Avoid using narrow (<1.2m) grassed verges to separate a footway from a carriageway

or from a private driveway as they are usually neglected and/or become overrun by vehicles.

- Where likely to be subject to vehicle incursion, grass verges must be protected by bollards.
- Grassed verges may include SuDS or other planting if agreed with the LHA.



This grassed verge alongside a footpath adds colour and makes a more welcoming space.



This small grassed verge serves little purpose and creates a maintenance burden.

DES 01

Highway Edges and Boundary Treatments

TECHNICAL CRITERIA

20. Foundations shall not be placed under the public highway.
21. The highway boundary, typically the back of footway, shall be defined by continuous 50mm x 150mm edging kerb type EF to BS 7263 laid flush, unless agreed otherwise. Alternative approaches to demarcation will be considered on a site-by-site basis, however, for example in conservation areas.
22. Kerb heights between footway and carriageway shall normally be:
 - 160mm at bus stops
 - 50mm in pedestrian priority areas, with the agreement of the highway authority
 - Flush at crossing points
 - 125mm elsewhere
23. Kerb heights between footway and cycleway or between cycleway and carriageway shall be 50mm unless splayed.
24. Dropped kerbs with tactile paving shall be provided at crossings in accordance with the standard drawings. Tactile paving design shall be consistent with the latest version of DfT Guidance on the Use of Tactile Surfaces.
25. For guidance on the configuration of the raised kerb area at bus stops, refer to DES 05 "Bus Infrastructure"
26. Layouts shall normally be designed to avoid combined kerb and drainage systems, unless agreed with the Highway Authority.
27. Where street trees are proposed, a tree's surface opening must be of sufficient size to allow infiltration of water and the aeration of the soil below. It must also be suitable to facilitate tree growth (notably radial trunk growth and flare) over time. Refer to page 67 of 'TDAG: Trees in Hard Landscapes: A Guide for Delivery' for guidance on surface opening treatments.
28. It is vital that root environments have sufficient access to water. This encompasses processes of infiltration, retention and drainage. Ensuring that trees are adequately spaced is crucial to allowing trees to grow and prosper as intended. Specific guidance for tree spacing shall be informed by the species of tree used.
29. It is important that trees incorporate an appropriate surface opening treatment.
30. It may be beneficial to establish common trenches for tree planting. This helps to minimise the space required to establish adequate planting and growth conditions and lessen the likelihood of conflict between space- competing elements such as tree roots and below- ground utilities infrastructure. Tree root expansion shall be facilitated in a way that protects the integrity of surface and sub-surface street infrastructure, including carriageways, footways, utilities and drainage. Root deflectors and other techniques may be considered as and where appropriate to context.
31. Where trees are planted directly into, or where the rooting environment is likely to overlap a load-bearing surface (e.g. a footway, a cycle track, the carriageway, a private driveway, etc.), efforts will likely be necessary to protect the rooting environment from soil compaction. This may include the use of proprietary below-ground systems,
32. Support structures will likely be necessary to protect and support young trees. Instances of subsidence encountered with trees planted in shrinkable clay and silt soils shall be negated by constructing to a suitable foundation depth and through appropriate species selection.
33. There shall be a minimum clearance below a tree's canopy as follows:
 - 5.1m – carriageway or vehicle parking area
 - 2.3m – cycleway or shared-use footway-cycleway (including footways where cycling is not permitted but can be expected, e.g.

DES 01

Highway Edges and Boundary Treatments

4

on routes to schools)

- 2.1m – footway

34. Choice of tree species will assist in future maintenance and trees' ability to retain shape after pruning, crown lifting, etc. Therefore, designers must engage with the city's trees and woodlands division and highways maintenance team when proposing new street trees.
35. These clearances should be assessed based on the shape and size of the tree at all stages of its growth cycle.
36. The impact of trees on visibility splays at junctions shall be considered within the context of the overall visibility envelope. Care should be taken to ensure that their obstructive effect is minimal. Trees that do not restrict visibility significantly may be acceptable such as those with narrow trunks.

ADOPTION AND MAINTENANCE

37. Boundary hedges, fencing and walling will not normally be adopted.
38. Any boundary treatment other than a kerb or edging which is subject to adoption shall incur a commuted sum and must be agreed with the LHA at the outset of the design process.

39. It will be necessary to establish who is responsible for maintaining boundary treatments in the early stages of the design process i.e. the concept development and design development stages.
40. It must be made clear to purchasers of individual property at the time of sale if ownership and responsibility for existing boundary hedges, fences and/ or walls is being transferred to them.
41. A commuted sum will be payable for grassed verges that lie outside of a visibility splay which are offered for adoption, as per the diagram below.
42. Service strips are not acceptable because these are often conflated with footways, leading to complaints. Where a corridor is required for utilities, this must be placed beneath the footway on a conventional street, or beneath the running surface on a shared surface street; see DES-19.
43. Highway trees must be fully planted before a provisional certificate of completion is issued. This planting must be maintained until the issue of the final certificate, including any necessary replacements, to make sure that it is fully established.

Verge outside of splay, not required for highway purposes. A commuted sum may be payable if adopted by the highway authority

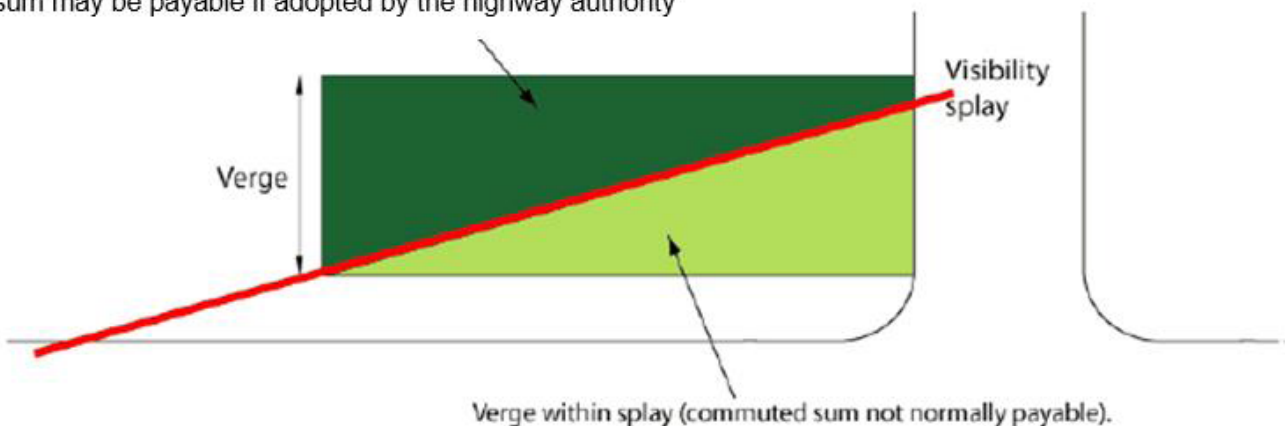

DES 01

Highway Edges and Boundary Treatments

LINKS AND REFERENCES

- a. This DES should be read in conjunction with Sections 1, 2 and 3 of the Leicester Street Design Guide.
- b. Leicester City Council Tree Strategy 2018-2023.
- c. Trees in Hard Landscapes: A Guide for Delivery (2014) Trees and Design Action Group (TDAG) provides extensive guidance on the design of street tree planting.
- d. For guidance on the use of tactile paving, refer to the latest version of DfT Guidance on the Use of Tactile Surfaces.



DESIGN ELEMENT SHEET

DES: 02

Subject: Public Art

Date:	17-05-2019	Version:	0.2
Author:	ANS	Approved:	BD

DESIGN CONSIDERATIONS

4

1. The use of public art is encouraged to help meet place-making objectives. However, public art will not form part of any highway adoption. Proposals for public art should be considered alongside quality streetscape strategies and take account of the following:
 - Consideration should be given as to how the use of public art enhances street character. Art that draws on local features, heritage or traditions can be effective in giving streets and places a stronger identity.
 - It may be appropriate to involve local communities in the development of public art proposals.
 - Artistic lighting may be considered as part of the overall street lighting design and public art strategy.

ADOPTION AND MAINTENANCE

2. Arrangements for future maintenance of public art that is not located in the highway will need to be established on a case-by-case basis. It is essential to consider/agree which body will be responsible for the future maintenance of any public art at the pre-application stage.
3. The LHA will issue a licence for approved artwork on the Public Highway.

LINKS

- a. Leicester City Council (2015), 'Public Art Guiding Principles'
- b. This DES should be read in conjunction with Sections 1, 2 and 3 of the Leicester Street Design Guide.

DES 03

Footways and Footpaths, and Access for Pedestrians



DESIGN ELEMENT SHEET

DES: 03

Subject: Footways and Footpaths, and Access for Pedestrians

Date:	17-05-2019	Version:	0.2
Author:	ANS	Approved:	BD

DEFINITIONS

- 'Footway' refers to any pedestrian path that adjoins a carriageway
- 'Footpath' refers to any other pedestrian link.

For the full definition, see: Highways Act 1980

DESIGN CONSIDERATIONS

1. Walking in new developments should be safe, convenient and with facilities designed to make this mode a viable and attractive alternative to the car. The key considerations are:
 - Providing good connectivity and permeability both within and beyond the development, including to local facilities, off-site bus stops etc
 - Designing street types which reflect a street user hierarchy that places pedestrians' needs at the top.
 - Managing vehicle speeds through layout design to ensure pedestrians and vulnerable users of the street feel safe.
2. An effective footway and footpath network is achieved by taking account of the following:
 - Pedestrian routes shall be short and direct, following desire lines wherever possible, to link people to places and to public transport facilities.
 - Culs-de-sac shall be minimised wherever feasible and where provided should by default be through routes for walking, and also for cycling.



This principal street in a development features an appropriately generous footway



This pedestrian link is well overlooked from adjacent buildings

- Pedestrian routes and connections should be well-lit and well-overlooked from adjacent buildings to minimise opportunities for crime

DES 03

Footways and Footpaths, and Access for Pedestrians

4

- Surfaces used by pedestrians shall be free from hazards that could cause them to trip.
 - Particular attention must be given to waste management practices and the proposed waste management options so pedestrian facilities do not get obstructed by wheelie bins, recycling bags, etc. on collection days
 - Street clutter on footways and footpaths should be minimised. Signs, trees, lighting columns and all other street furniture shall be located into a clear and consistent "furniture zone" which should be additional to the footway minimum width required.
 - Pedestrian guardrailling shall be limited to very specific circumstances such as outside schools where it may need to be considered. Where it is used the minimum required useable footway widths should still be provided.
 - Footways and footpaths shall be resilient to tree growth and on-footway parking (even though the latter is not desired) to maintain the integrity of the surface for visual and safety purposes.
 - Where a proposed building fronts directly on to the highway, it shall be set back a minimum of 0.5m behind the proposed highway boundary to allow for opening of windows, drainage downpipes, overhanging eaves, etc.
 - Any obstruction to or proposed diversion of a Right of Way (RoW). the applicant will need to obtain a diversion order from the RoW Authority. The applicant will normally incur all costs associated with this process
3. Except in shared private drives and other type of shared surfaces, pedestrian access to developments will normally be taken from the footway.

4. Pedestrian access to dwellings must ensure that:

- It is possible to gain access to the dwelling, or building containing the dwelling, from the most likely point of alighting a car.
- Step-free accesses are provided where feasible to take into account the needs of a diverse number of users.



Wheelie bins limit the use of footways, especially by people with disabilities and people with pushchairs. These problems should be eliminated through the design.



Poor quality and poorly overlooked pedestrian link

DES 03

Footways and Footpaths, and Access for Pedestrians

TECHNICAL CRITERIA

5. Minimum, unobstructed footway or footpath width shall be:
 - 2m - minimum footway width for residential, commercial and industrial footways.
 - 3m - minimum footway width where street trees are provided, at a bus stops and outside education and healthcare premises.
 - 4m - minimum footway width in shopping areas.
6. Minimum footway width at bus shelters shall be:
 - 1.3m - minimum footway width to be provided at the rear of any cantilever bus shelter in areas of low pedestrian activity.
 - 2m - minimum footway width to be provided at the rear of any cantilever bus shelter in areas of high pedestrian activity.
7. Footway and footpath widths past an obstacle (e.g. bollards, sign posts, street lighting columns, utility equipment) shall be:
 - 1.2m - absolute minimum in areas of low pedestrian activity.
 - 1.5m - preferable minimum in areas of low pedestrian activity.
 - 2.0m - minimum in areas of high pedestrian activity.
8. Longitudinal footway and footpath gradient shall be:
 - 1:100 - minimum.
 - 1:20 - maximum. This gradient may be relaxed to 1:12 in order to account for the needs of people with impaired mobility on streets with particularly difficult topography.
9. Footway and footpath crossfall shall be:
 - 1:40 (Maximum crossfall), including at footway crossovers (see DES 16)
10. Other criteria:
 - Building elements shall not overhang footways or footpaths at a height less than 2.6m, or 2.7m over routes used by cyclists (See note under 'Adoption and Maintenance' concerning the need to obtain a license).
 - Planting shall not impinge on footway or footpath width.
 - Pedestrian visibility splays shall normally be constructed to 2.0m x 2.0m on each side.
 - Highways shall be designed such that vehicles are not expected to over-run the footway. Parking controls may be required to ensure carriageway space is clear for manoeuvring such that footway incursion is not required. Where there may be residual concerns about footway overrun, footway protection by means of bollards shall be provided.
11. Pedestrian accesses to dwellings shall:
 - Be level, gently sloping, or where necessary, ramped. On steeply sloping plots, where step-free access is unattainable, a stepped approach may be used providing it can be demonstrated that there is no alternative design solution.
 - Be constructed with a hard-bound material.
 - Have a 900mm minimum clear width (including past a parked car) to facilitate wheelchair access.
 - Have a 1 in 40 maximum crossfall.
12. If ramped, the approach route shall:
 - Not be more than 10m long if gradient is up to 1:15 - for individual flights.
 - Not be more than 5m long if gradient is up to 1:12 - for individual flights.
 - Have a 900mm minimum clear width between individual flights.

DES 03

Footways and Footpaths, and Access for Pedestrians

- Ensure that every flight has a top and bottom landing.
- Provide an intermediate landing between individual flights and at any change of direction.
- Have a 1,200mm minimum length of landing (clear of the swing of any door or gate).

ADOPTION AND MAINTENANCE

4

13. The highway authority may adopt footpaths as Public Rights of Way where they have been constructed and lit to a satisfactory level, for example, where they form part of a wider network (existing or planned) or provide a more direct link to local destinations beyond the site such as:
 - An employment or shopping centre.
 - A school or other community or leisure facility.
 - A bus stop or public transport.
14. Where aesthetic, environmental or other such reasons dictate that non-standard surfacing materials be used, these must be agreed at an early stage. Such materials must meet requirements of quality, durability, maintainability and sustainability and may attract a commuted sum
15. If any part of a building projects over the adoptable highway, the developer will need to apply for a licence under Section 177/178 of the Highways Act before the street can be adopted.

LINKS AND REFERENCES

- a. This DES should be read in conjunction with Sections 1, 2 and 3 of the Leicester Street Design Guide.

DES 04

Cycle Streets and Space for Cycling

**DESIGN ELEMENT SHEET****DES: 04****Subject: Cycle Streets and Space for Cycling**

Date:	17-05-2019	Version:	0.2
Author:	ANS	Approved:	BD

DESIGN CONSIDERATIONS

- There are three types of acceptable cycle route:
 - Quiet mixed-traffic streets
 - Off-street routes
 - Space for cycling on busier highways
- When considered early enough in the development process, designing for cycling can add to the quality of a street – see the example from Cambridge opposite – rather than detract from it. Therefore, the requirements for cycling infrastructure will normally be discussed with the highway authority as part of the pre-application discussion process

facilities are provided where the development is connected to the wider highway and cycle network, including potential future routes.

- The following table, taken from the Wales Active Travel Design Guidelines (endorsed by DfT for use in England in the draft LTN 1/19) shows how the need for separate cycle facilities is dependent on the speed and volume of motor traffic.

4



Principal street through new development, Cambridge - off-carriageway one-way cycle track separated from the carriageway by a swale

- Particular attention will need to be given to the points of access to the site, including any new junctions, to ensure that appropriate cycle

DES 04

Cycle Streets and Space for Cycling

4

Speed Limit/Design Speed	Number of motor traffic lanes	Motor traffic flow (AADT)	Preferred minimum provision by cycle route type		
			Secondary cycle route	Primary cycle route	
20 mph	Irrelevant	1 – 2,500	Quiet streets: Combined traffic	Cycle streets or quiet streets: Combined traffic	
		2,000 – 5,000		Cycle lanes	
		> 4,000	Cycle lanes		
30 mph	2 lanes in total	0-5,000	Cycle tracks		
		> 4,000			
	≥ 2 lanes	Irrelevant			
≥ 40 mph	Irrelevant		Cycle tracks (excluding light segregation and stepped tracks)		

Degrees of segregation for cyclists



Notes

- *Designers shall always consider the potential to reduce motor traffic speed and volume to create acceptable conditions*
- *There is some overlap between motor traffic flow ranges to allow for flexibility*
- *Speed means speed limit, but if actual speeds are significantly higher, consider next highest category of speed*
- *Cycle tracks includes light segregation and stepped tracks unless noted*

DES 04

Cycle Streets and Space for Cycling

CYCLE STREETS

- While all of the quiet street network on residential developments will normally be suitable for cycling, on larger sites it may be appropriate to identify particular streets as the main cycle grid. This might be useful where these streets lead to a greenway or cycle-only access point to the site. Such 'cycle streets' should be easily identifiable through distinctive design features to aid legibility.

OFF-HIGHWAY ROUTES

- Off-highway routes (sometimes referred to as greenways) can use a wide range of corridors, including public open spaces and routes along watercourses.
- It is generally preferred for pedestrians to be accommodated on a separate footpath, rather than both groups being expected to use a shared use path. Where facilities are separate cyclists are able to maintain a higher speed and there is reduced perception of conflict by both groups. The segregation must be effective, using features such as contrasting materials, a change in levels and/or a grass verge.
- Exceptions to the above will be in pedestrianised areas or other situations where segregation is deemed to be undesirable. Such exemptions will be specified by or agreed with the LHA at the pre-application stage.



Off-highway cycle track and footpath separated by level and contrasting material with good quality surface and lighting



This cycle-only link through a local street increases cycle permeability

- Segregation between pedestrians and cycles using only a white line (even if raised) will not be effective and is not acceptable on new developments - see Local Transport Note 1/12. A different material and change of level is the preferred method of segregation so that users can easily recognise the different functions visually and tactilely.

DES 04

Cycle Streets and Space for Cycling

10. Off highway cycle routes shall primarily be designed as high-quality links for purposeful journeys rather than simply leisure facilities. Routes shall:
- Be direct and follow desire lines wherever possible.
 - Avoid steep gradients.
 - Have widths designed to accommodate peak forecast demand.
 - Achieve minimum visibility and corner radii based on the appropriate design speed.
 - Use good quality bound surface materials.
 - Be lit and well drained
11. Routes shall not have
- Restrictive access controls that slow cyclists and prevent access by a range of cycle types.

SPACE FOR CYCLING ON BUSIER HIGHWAYS

12. Where cycle tracks are required on busier streets, they should normally be uni-directional cycle tracks, one on each side of the carriageway. This means that cyclists enter and leave junctions on the correct side of the carriageway, which reduces conflict and simplifies layouts. However two-way tracks may be appropriate in areas with a high concentration of destinations on one side of the street.
13. Cycle tracks may be set back from the carriageway edge and separated from it by a verge, swale and/or car parking. Such tracks should be at or slightly below the level of the footway and paved in a contrasting material.
14. Where cycle tracks are below footway level but above carriageway level, these are known as “stepped” cycle tracks. These normally transition back to footway or carriageway level at junctions, depending on the specific junction treatment.
15. Priority over side road turning traffic is highly

desirable as this increases the range of cycling and reduces effort.

16. At very minor junctions, this can be achieved by continuing the cycle track across the junction at the same level and marking it in such a way that it is clear to turning motorists that they must give way to cycle traffic. This is analogous to the use of dropped kerbs rather than constructed radii for minor accesses.



Continuous cycle track and footway across side road, London

17. At moderately busy junctions, the cycle track should be set back from the main road to provide a waiting area for traffic turning into the side road to stop and give way to cyclists. The depth of the set-back may need to be proved by modelling, including an assessment of the frequency with which large vehicles may be expected to need to give way, but 5-6 metres is typical for residential streets.

DES 04

Cycle Streets and Space for Cycling



Bent-out crossing, Leeds (Image used under Creative Commons licence CC- BY-SA 3.0, from Cycle Streets photo map: www.cyclestreets.net/location/89767)

18. At very busy junctions, signalisation may be the preferred method of giving cyclists priority over turning traffic.
19. Cycle tracks should be coloured to highlight their presence at conflict points and to show that their use is different to any adjacent carriageway, footpath or footway.
20. Naturally-coloured aggregate shall be used in for cycle track surfacing, as this provides the most long-lasting construction and the best ride quality. Dyed aggregates or surface overlays will wear away and thus will not be accepted unless agreed by the highway authority at specific locations.
21. Where cycle tracks meet bus stops the preferred solution is for them to continue past the bus stop on the left hand (footway) side. Designs must meet the principles as set out in the main Leicester Street Design Guide.



Stepped cycle track at priority junction, Cambridge



Bus Stop Bypass, Brighton

TECHNICAL CRITERIA

22. For full information, reference should be made to the London Cycling Design Standards, DMRB CD 195, and Local Transport Note 1/20 (when published).

DES 04

Cycle Streets and Space for Cycling

4

CYCLE LANE WIDTHS

Situation		Width
Nearside lanes	Desirable minimum	2m
	Absolute minimum	1.5m
Nearside lanes on approach to Advanced Stop Lines (ASLs)	Absolute minimum for short lengths	1.2m
Central feeder lanes to ASLs	Absolute minimum	2m

Notes:

Nearside lane dimensions also apply to bus stop bypasses. Desirable minimum island width = 2m. Minimum bypass entry / exit taper 1:10

Where cycle lanes are adjacent to parked cars there shall be a minimum buffer zone of 0.5m to allow for the opening of car doors.

CYCLE TRACK WIDTHS

Cycle Route Type	Peak Hour Cycle Flow	Desirable Minimum
1-way cycle track (including stepped cycle track)	<150	2.0m
	>150	2.5m
2-way cycle track	<50	2.5m
	50-150	3.0m
	>150	4.0m

HORIZONTAL AND VERTICAL ALIGNMENT

- 23. Where cycle tracks are within highways, the alignment will normally be acceptable
- 24. For off street routes, the alignment shall be adequate to allow cyclists to travel at their desired speed. Most cyclists will wish to travel between around 12mph (20km/h) and 18mph (30km/h). Based on these speeds, plus a lower design speed of 6mph (10km/h), recommended key geometric criteria are shown in the following table

Parameter		Design Speed		
		18mph (30kmh)	12mph (20kmh)	6mph (10kmh)
Minimum forward visibility	Desirable	80m	50m	30m
	Preferred	30m	30m	30m
	Absolute	25m	15m	10m
Minimum horizontal curvature, inner radius	Absolute	25m	15m	4m
Vertical curvature, crest K value	Desirable	5.0		
	Preferred	1.6		

- 25. Where possible, cycle routes shall avoid steep gradients. The maximum desirable gradient depends on length. People are better able to tackle short steep gradients, but even relatively gentle gradients can become difficult if they are sustained.

Gradient		Maximum Length of Gradient (m)
2.0%	1:50	150
2.5%	1:40	100
3.0%	1:33	80
3.5%	1:29	60
4.0%	1:25	50
4.5%	1:22	40
5.0%	1:20	30

LINKS AND REFERENCES

- a. For further details on cycling infrastructure refer to the London Cycling Design Standards, DMRB Interim Advice Note 195/16, and Local Transport Note 1/19 (when published).
- b. For information on cycle parking refer to DES-14.
- c. This DES should be read in conjunction with Sections 1, 2 and 3 of the Leicester Street Design Guide.

DES 05

Bus Infrastructure

**DESIGN ELEMENT SHEET****DES: 05****Subject: Bus Infrastructure**

Date:	17-05-2019	Version:	0.2
Author:	ANS	Approved:	BD

DESIGN CONSIDERATIONS

1. There are two component design elements to bus infrastructure:

- Bus Routes
- Bus Stops

BUS ROUTES

2. A bus route refers to any section of carriageway designed to facilitate bus operations. In rural and outer suburban areas, bus routes will likely be shared with general traffic; however, in urban areas, they may be provided with some degree of segregation from general traffic through bus lanes or other types of bus priority.

3. It is highly desirable that:

- Public transport services and infrastructure to new development is integrated with the pedestrian and cycling network.
- Dwellings and other trip generators are desirably within 250m walking distance of a bus stop.

4. However, there is a trade-off between bus stop accessibility and bus service quality; therefore, longer walking distances may be appropriate for some users if this avoids a bus service being convoluted and indirect. Nevertheless, destinations attracting a large number of passengers or passengers likely to have mobility restrictions should be located as close as possible to a bus stop.

5. Developments shall be as permeable to bus operations as possible. Where appropriate, bus priority measures such as bus lanes, bus

gates and traffic signals shall be used to aid bus movement.

6. Bus operators shall be engaged at a suitable point in development team discussions where bus routes are being planned through a development. These discussions should be conducted via the highway authority.
7. All bus routes shall be able to accommodate bi-directional bus flows (unless a one-way system is proposed) and avoid car parking arrangements that may impede bus movement and create safety issues for pedestrians and cyclists.
8. Streets for use by public transport shall, as far as possible, be reasonably straight to minimise travel time and distance. Sharp corners shall be minimised; however, if they are necessary, they shall be capable of accommodating the swept path of the largest likely specification of bus and be validated using a tracking assessment.
9. For some developments, particularly larger sites, bus-only links or bus gates to achieve good permeability for buses may be appropriate. Any such designs will normally:
 - Require a Traffic Regulation Order (TRO) to control its use by other vehicles.
 - Incorporate an appropriate control system if it is likely that the link would be used by other traffic e.g. automatic rising bollards.
 - Include walking and cycling links.

DES 05

Bus Infrastructure



Bus gate

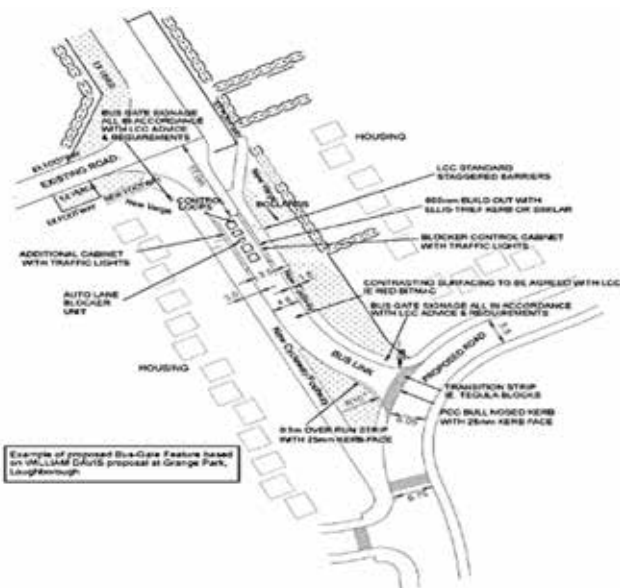

Example of a bus-only link

10. The quality and location of bus stop facilities are crucial to encouraging people to travel by bus. The following matters shall be taken into account:

- Buses shall be able to stop parallel to the kerb and at a distance no greater than 50mm from it. Where on-street parking is present in the vicinity of the bus stop, it may be beneficial to build additional design features into the bus stop, such as a built-out boarded, to ensure that this parameter is achievable.

- Bus stops in urban areas shall be positioned to maximise the convenience of interchange with other bus stops and between other public transport modes.
- Bus stops located in the vicinity of junctions shall be set far enough back from the junction so as not to affect the operability and safety of the junction.
- Where locating bus stops at junctions in urban areas, it is preferable that they are placed on the exit side of the junction. Any bus stops located on the entry side shall be positioned upstream of any bus priority detection signalling equipment.
- Where a bus route runs in both directions along a street, bus stops shall normally be provided in pairs. These shall be offset at a safe distance to allow traffic to pass in between stationary buses.
- The bus "cage" (the yellow bus stop marking on the carriageway) shall normally be placed in the main carriageway for priority. Any solution (such as bus bays or lay-bys) that compromises the priority of the bus shall be avoided. However, there may be some locations where such features are appropriate. This will be directed by the Highway Authority at the pre-application discussion stage.
- A pedestrian crossing shall be provided in the vicinity of a bus stop (yet positioned at a safe distance from the bus cage) to enable bus stop users to cross the street at ease. This could be a formal crossing facility (e.g. a zebra crossing) or an informal crossing facility (e.g. an urban design feature with a flush kerb) depending on the context.
- When proposing a new bus stop, appropriate pedestrian links shall be provided/existing routes enhanced.

DES 05

Bus Infrastructure

- Street furniture in the bus stop area shall be restricted to only the most necessary items. Items of street furniture must not obstruct passengers boarding and alighting, particularly wheelchair users and passengers with pushchairs. Street furniture that is not necessary for the safe and satisfactory function of the bus stop shall be rationalised and located beyond the limits of the bus cage in the downstream direction, and preferably not within 20m of the bus cage in the upstream direction for visibility purposes
- Bus stops in employment or commercial areas shall be positioned near to building entrances where this is feasible.

TECHNICAL CRITERIA

BUS ROUTES

11. Carriageway widths for two-way traffic:

- 6.0m minimum.
- Tracking assessments need to be provided to validate the suitability of the carriageway widths for all streets subject to bus movement based on the largest likely specification of bus for the route in question

SPEED-CONTROL SPECIFIC TO BUS ROUTES

12. The aim shall always be to manage speeds through layout design. In circumstances where this is not feasible, however, early engagement with bus operators and public transport section of the LHA will be necessary.
13. Vertical traffic calming shall not be used on bus routes unless there is no other practicable speed control solution.
14. For ramp gradients, see DES-06.

BUS STOP LAYOUT

15. The layout of bus stops shall be in accordance with local authority requirements which shall be agreed. These requirements normally include:

- 3m - minimum clear unobstructed footway width at a bus stop. Where there is significant pedestrian activity wider footways will be required.
- 2.0m x 2.0m - minimum size of clear area to be provided on the footway - to be measured from the end of the bus ramp (at a gradient no steeper than 1 in 8 (12%)) and the rear edge of the footway. This space is to allow wheelchair users to manoeuvre comfortably when boarding and alighting.
- The bus stop flag must be positioned at the kerb.
- The bus shelter shall normally either be positioned 0.5m from the edge of the kerb facing inward, or at the back of the footway facing outward towards the carriageway. When positioned near to the kerb, the 2.0m x 2.0m clear area must be provided between the bus stop flag and the shelter to allow wheelchair users to manoeuvre.



DES 05

Bus Infrastructure

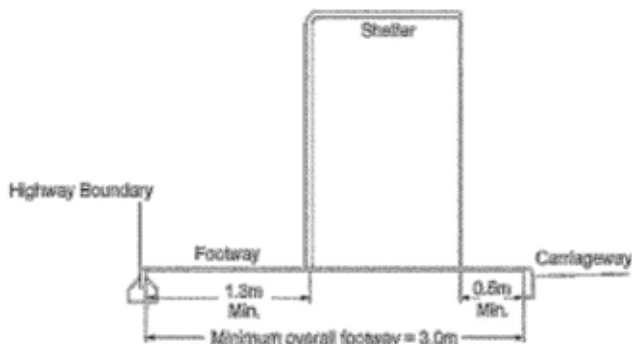

4 Example of kerbside bus stop layout, based on TfL (2006) Accessible Bus Stop Design Guidance

- 1.3m - minimum clearance distance behind the bus shelter when the shelter is located near the kerb. Where there is significant pedestrian activity, increased clearance distance might be required.
- 1.8m minimum - clearance distance in front of the shelter when positioned at the rear of the footway. Where there is significant pedestrian activity, increased clearance distance might be required.
- 160mm - kerb height at a bus stop and to be deployed for a minimum length of 6.0m (access kerb). This length shall be extended at multiple-length bus stops as per the bullet point below
- The bus cage shall normally be marked (in accordance with TSRGD 2016) to discourage vehicles from parking in it and obstructing the operation of the bus stop. The bus cage length shall be determined by tracking, which demonstrates that clear entry and exit is possible and the bus can pull up parallel to the raised boarding area. Additional length shall be added at sites where two or more routes serve the same stop.
- 2.0m - width for a full width boarder, where the bus stop is built out between parking bays to obviate the need for buses to manoeuvre into and the stop and then wait to regain their place in the traffic stream.

16. If location criteria relating to access distances to bus stops cannot be met satisfactorily or where demand is likely to be low, it may be preferable to advocate a hail-and-ride model through the development allowing passengers to hail the bus from any point along the designated bus route. In such instances, information posts shall be erected along the route to provide bus service information at an agreed spacing. To rationalise street furniture, it may be preferable to build these into lighting columns. Access kerbs (160mm height) shall also be provided to allow for accessible boarding and alighting. A TRO may be required to prevent parking along lengths of access kerb.
17. The viability of a hail and-ride model must be discussed with the LHA and bus operator from the outset of the design process.
18. Whether erecting a new bus stop or relocating an existing one, the agreement of the LHA will be required. The LHA will decide whether the following need to be consulted:
 - The police
 - The bus operators
 - Direct frontagers
 - Statutory consultees specified by the LHA
19. The full extent of consultation shall be discussed with the LHA.
20. Where advertising is to be displayed at a bus shelter, advertisement consent will need to be sought from the LPA.
21. Issues and agreement on a general approach for bus stop locations and bus provisions shall be agreed at the design development stage as these may have a bearing on:
 - The layout of the development.
 - Any transport assessments, transport statements and/or travel plans required.

DES 05

Bus Infrastructure

- Off-site highway mitigation works.
 - Parking provision.
22. For larger sites, all public transport facilities and routes shall be clearly identified as part of the concept development stage.

ADOPTION AND MAINTENANCE

23. The LHA will normally adopt bus stop infrastructure and will require a commuted sum.
24. Bus routes within private streets are not desirable from a service management perspective, hence any new bus-served street should normally be offered for adoption.

LINKS AND REFERENCE

- a. CIHT (2018), 'Buses in Urban Developments'
- b. TfL Accessible Bus Stop Design Guidance 2006.
- c. TSRGD 2016.
- d. DES-06 and DES-12.
- e. This DES should be read in conjunction with Sections 1, 2 and 3 of the Leicester Street Design Guide.

DES 06

Carriageways and Vehicle Track Space



DESIGN ELEMENT SHEET

DES: 06

Subject: Carriageways and Vehicle Track Space

Date:	17-05-2019	Version:	0.2
Author:	ANS	Approved:	BD

DESIGN CONSIDERATIONS

FUNDAMENTAL PRINCIPLES

4

1. Streets within new development areas shall either be 'Conventional Streets' (i.e. streets with footways) or 'Shared-Surface Streets' (i.e. streets without footways).
2. Regardless of street type, some fundamental requirements of carriageways and vehicle track spaces must be met:
 - Safety and comfort for all users
 - Fitness for purpose
 - Access and manoeuvrability emergencies
 - Access and manoeuvrability for servicing and turning
3. Even if streets are not offered for adoption, meeting the requirements of the Leicester Street Design Guide is highly desirable.



Conventional Street with build out, defined car parking bay and street trees.



This small housing development has a simple U-shaped one-way system street layout and controlled on-street parking in place, which aids refuse collection vehicles in navigating the site.

SAFETY, COMFORT AND PURPOSE

4. The design speed of a street shall reflect its function. The design speed shall determine critical safety factors such as visibility splays, which are based on sight stopping distance (SSD).
5. Sight Stopping Distance (SSD) is the distance that a driver needs to see ahead in which to provide sufficient reaction and braking time to bring their vehicle to a halt at a reasonable rate of deceleration in the face of a hazard or an obstacle.
6. While minimum SSDs shall be considered as a starting point, the rigid application of these values at bends can lead to higher than desirable speeds.

DES 06

Carriageways and Vehicle Track Space

7. Research in Manual for Streets suggests shows that reducing forward visibility in residential streets tends to reduce speed which will be beneficial to road safety.
8. Therefore, where the design speed is 20mph or less, forward visibility around bends may be reduced to a minimum of 15m by adopting appropriate building lines or other means such as planting, street trees or car parking. Forward visibility shall be measured from the centre of the inner lane.



A bend where the generosity of the forward visibility will tend to encourage excessive speed



Parking has been used on this bend to restrict forward visibility

9. Where the street serves a mix of land uses, the design speed shall be for the land use with the lowest design speed - e.g. if residential dwellings are present, the street shall be designed to 20mph. The design speed for other types of highway shall be agreed with the LHA at the pre-application discussion stage.

10. In some cases, designing-in speed control will be necessary to ensure motorists travel at the desired design speed.
11. The means of controlling speeds are many and varied and the appropriate form(s) for development will depend on context. However, in all instances, consideration should be given to how street layout and the urban form can contribute to speed control - i.e. the relationship between streets, buildings and landscape; and to the self-enforcement of design speed.
12. Methods of implementing speed control through street layout and urban form include:
 - Carriageway widths that do not exceed those necessary for the size of vehicles anticipated.
 - Changes in horizontal alignment. However, gentle meandering alignments will not reduce speeds significantly and should be avoided.
 - Junctions where there is a loss of priority and where the junction is raised to footway level.
 - Building orientations, plot layouts, and planting etc. to restrict forward visibility to that relevant to the design speed.
 - The avoidance of junction visibility splays that are in excess of those required for the design speed; see DES-09 for junction visibility parameters.
 - The choice of, and variations in, carriageway surface materials.
 - The use of street trees and planting to create a sense of enclosure.
 - Design of on-street parking to force drivers to 'take turns' in passing on lightly-trafficked streets

DES 06

Carriageways and Vehicle Track Space

4



Speeds in this development are limited through design and layout. Alignment, width and landscaped verges are key components.



Sharp bends and restricted forward visibility used as a speed control measure. Image courtesy of Andy Cameron.

13. Where the built form is insufficient to control speeds, engineered traffic calming measures may be considered, but only as a last resort design solution. Where used they should be designed to enhance the street scene.
14. The selection of traffic calming measures shall:
 - Take into account the needs of pedestrians, cyclists and motorcyclists.
 - Ensure that speed calming measures do not interfere with the sense of place.



Over-engineered traffic calming should be avoided.

15. Raised tables can be placed at junctions, side roads entries/ exits or on straight sections of carriageway to slow vehicle speeds and facilitate pedestrian crossing activity at important crossing points. Raised tables imply changes in relation to the street's operation and give informal priority to pedestrians.
16. Design speed and expected traffic volumes will determine the necessity of separate pedestrian and cycle infrastructure. A pedestrian footway is usually expected by the LHA, except in where the application of a 'Shared-Surface Street' is appropriate; refer to DES-07.
17. Footways shall conform to the requirements set out in DES-03.
18. The need for cycle infrastructure within or adjacent to the carriageway is determined by the mandatory requirements set out in DES-04.
19. The carriageway or vehicle track width may vary along the street. Localised variations in width can be effective where the street layout is designed to respond to the nature of the built form, street trees or planting or to provide on-street parking spaces.

DES 06

Carriageways and Vehicle Track Space

20. The broad spectrum of vehicles need to be accommodated in new developments. As such, street layouts shall be designed to:
- Prioritise the needs of pedestrians, cyclists and vulnerable road users such as motorcyclists.
 - Provide motor vehicles with suitable and convenient access to the external highway network.
 - Discourage external motor traffic from using the minor street network as a through route.
 - Accommodate public service vehicles, such as refuse collection vehicles by maximising the efficiency by which they carry out their duties (e.g. by minimising the need for turning and reversing manoeuvres).
21. All streets must be tracked using the largest vehicle that might require regular access (likely to be a refuse collection vehicle) to demonstrate suitability. Tracking assessments shall always account for the potential for on-street parking, whether in dedicated facilities or just on-street.
22. Larger vehicles which are only expected to use a street infrequently, such as pantechnicons, need not be fully accommodated provided that safe access and manoeuvring can be agreed with the highway authority and demonstrated by tracking.
23. If a street is designed with the intention of providing a bus route, either immediately or at some point in the future, the largest likely specification of bus vehicle shall also be included in the tracking assessment.
24. On conventional streets with a carriageway width of less than 6m, or which are on a proposed or potential bus route, it will normally be necessary to prevent indiscriminate parking, including on footways, by providing defined parking bays outside the carriageway or by parking controls.
25. Within new development areas, and particularly where development has frontage access to the street, the swept path could use both sides of the carriageway or vehicle track to enable consideration to be given to tight junction radii to allow more direct and convenient pedestrian and cycle desire lines to be achieved. This approach will not necessarily apply at proposed junctions to the existing highway network.
26. Whether or not the swept path can use the whole carriageway in these circumstances will be dependent upon the context and the agreement of the LHA. Tracking analysis shall be undertaken at an appropriate vehicle speed.
27. New residential developments usually need to provide at least two access points to the existing street network. This is important to help emergency services achieve response time requirements.
28. However, "emergency only" accesses are not normally accepted because of:
- Enforcement problems arising from their misuse.
 - Difficulties encountered by the emergency services.
 - Maintenance issues and vandalism of access-control equipment.
 - General crime and anti-social behaviour problems.

DES 06

Carriageways and Vehicle Track Space

4



Due to vehicle size, requirements for emergency access is normally dictated by the fire service

29. Emergency services must be consulted throughout the pre-application stage via the highway authority, particularly where traffic calming measures are proposed for key routes. This is especially important for vertical calming measures.
30. In certain circumstances, there may be a valid reason for only providing a single point of access, particularly where the land being developed has limited frontage to a public highway. Where this is the case and emergency accesses are required it must be ensured that:
- Street safety is not compromised.
 - The access is not likely to be a source of crime or anti- social behaviour problems.
 - There are appropriate means of controlling its use.
 - Emergency services have been fully consulted and the proposals are acceptable. Standard heights of emergency vehicles, particularly large fire service vehicles, shall be confirmed with the relevant emergency service at the pre-application stage in order to provide suitable headroom compliant with unrestricted height requirements for the area.

- Long-term maintenance responsibilities are clearly defined and secured.
 - Additional dedicated pedestrian and cycle access points exist.
31. Because of the preference for connected networks of streets there shall be a limited need for turning areas in new developments.
32. However, turning areas will be required in the following circumstances:
- At the ends of culs-de-sac
 - Either side of a mode filter (e.g. bus or cycle gate)
 - Where a proposed development takes private access from a road with a speed limit above 40mph.
 - Normally required where a proposed development takes private access from a highway that carries in excess of 500 vehicles per hour at its peak.
 - Preferably to be constructed within 50m of the access junction for employment and commercial developments.
 - Required elsewhere where road safety may be compromised.
33. Layouts which require large vehicles such as refuse vehicles and/or a fire tender to reverse are wasteful of space and make servicing less efficient.
34. Where they are provided the design of the space provided should relate to its local context and the buildings that surround it, not specifically to the needs of vehicle movement.
35. The dimensions of the space provided should be determined through vehicle tracking. Examples of layouts are shown opposite.
36. Any turning area shall be designed to discourage car parking within it, which otherwise might compromise its functionality.

DES 06

Carriageways and Vehicle Track Space

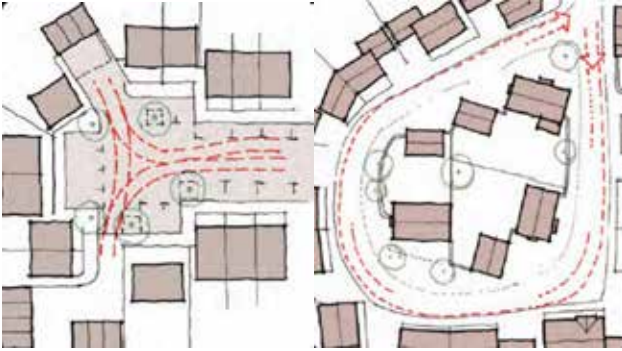

Illustrative layouts for turning areas.

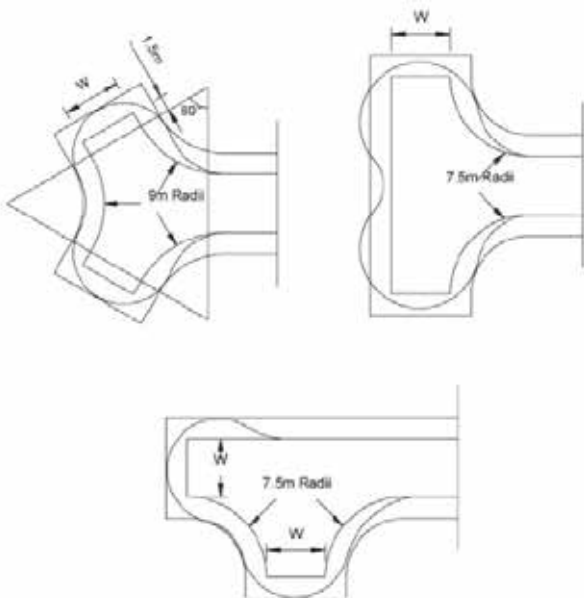

W = 4.8m up to 50 dwellings
W = 5.5m from 50 - 400 dwellings

Dimensions of conventional turning heads

TECHNICAL CRITERIA

FORWARD VISIBILITY

37. The SSD values in Table 6.1 are based on the 85th percentile design speed and account for bonnet length:

Table 6.1 - Stopping Sight Distances

Design Speed	Stopping Sight Distance
15mph	18m
20mph	25m
25mph	33m
30mph	43m

¹pja.co.uk/stopping-distance-calculator/

- 38. If the street is positioned on a slope or with a bus/HGV flow of more than 5% the SSD value may need to be revised. Where this is the case, the SSD shall be calculated using the Stopping Sight Distance Calculator.¹
- 39. Visibility in the vertical plane shall be measured from a driver's eye height of no less than 1.05m above the street's surface to a point no less than 0.6m above the street's surface. This shall be reduced to 0.26m if the measured or design speed on the street is above 30mph (85th percentile). This will be most relevant in the context of visibility at site access junctions.
- 40. Any structures such as bridges or natural gradient changes that inhibit vertical visibility along an otherwise linear street may require some form of mitigation through design to ensure the safety of all street users.

HORIZONTAL ALIGNMENT

- 41. Appropriate carriageway widths will vary according to the highway function. A street network hierarchy shall be agreed with the LHA at the earliest opportunity in the development design process, so appropriate carriageway / vehicle track widths can be determined.
- 42. Variable width carriageways are considered acceptable providing it can be demonstrated through tracking analysis that swept paths are accommodated.
- 43. Streets with lane widths of between 3.1m and 3.9m shall be provided with separate cycle facilities, as these widths fall in the 'critical' zone where cyclists may be passed by motor vehicles with insufficient clearance. Therefore, DMRB-standard 7.3m carriageways will not normally be acceptable where cyclists are expected to mix with motor vehicles.
- 44. Lightly-trafficked streets may be narrowed to a single lane for short lengths to control speeds. Carriageway widths should typically be a maximum width of 3.1m so that cyclists can ride in 'primary position' (see DES 04).

DES 06

Carriageways and Vehicle Track Space

4

45. Similarly, at local restrictions such as pedestrian refuges, single lane widths of between 3.1m and 3.9m should be avoided unless a separate cycle facility is provided.

46. The minimum width for fire access routes shall be 3.7m.

47. Carriageway and vehicle track centre-line radius shall be:

- Residential and B1 office uses – to be determined by tracking
- B2 to B8 uses – 55m minimum.

48. Note that 'centre-line' does not imply that an actual marked centre line is required. The absence of a centre-line can be an effect method of speed restraint.

VERTICAL ALIGNMENT

49. Cross fall shall be 1:40 maximum.

50. Longitudinal gradients shall be:

- 1:100 – flexible surfacing minimum.
- 1:80 – block surfacing minimum.

- 1:20 – desirable maximum
- 1:12 – maximum permissible gradient on steep sites.
- 1:20 - maximum at junctions for the first 5m of the side road.

51. Vertical curve lengths shall be based on the formula $L = K \times A$ where:

- A = algebraic difference of the gradients expressed as a percentage, see figure below.
- L = length of vertical curve (m)
 - 10m minimum, design speed 20mph or less
 - 25m minimum, design speed over 20mph
- K = constant
 - 1.0 minimum, design speed 20mph or less
 - 4.0 minimum, design speed over 20mph

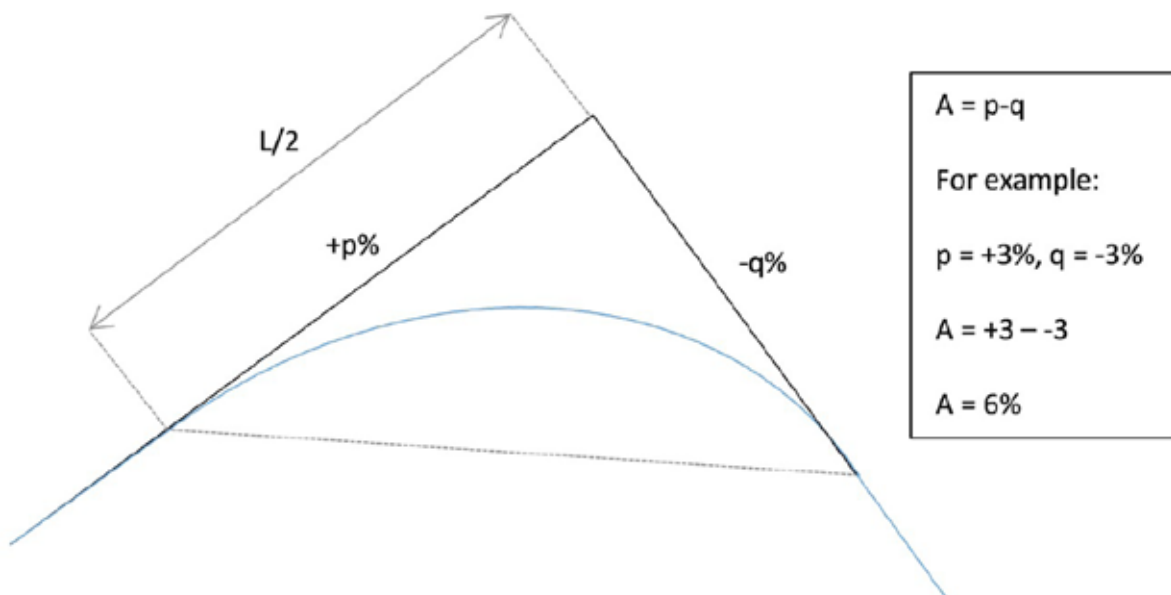

DES 06

Carriageways and Vehicle Track Space

52. Raised tables shall normally have a minimum plateau length of 7m and a maximum height of 75mm, and be profiled as shown below.

VEHICLE SWEPT PATH

53. Tracking assessments shall be undertaken to validate the functionality of turning areas and emergency routes. This will obviously include

a refuse vehicle and a fire tender, but specific vehicle specifications should be agreed with the highway authority at the pre-application discussion stage.

54. For information on refuse vehicle specifications, please contact: waste.management@leicester.gov.uk

All construction joints to be saw cut and painted with bitumen in accordance with BS594 part 2

Ramp gradients to be 1:8 or 1:12 for bus routes

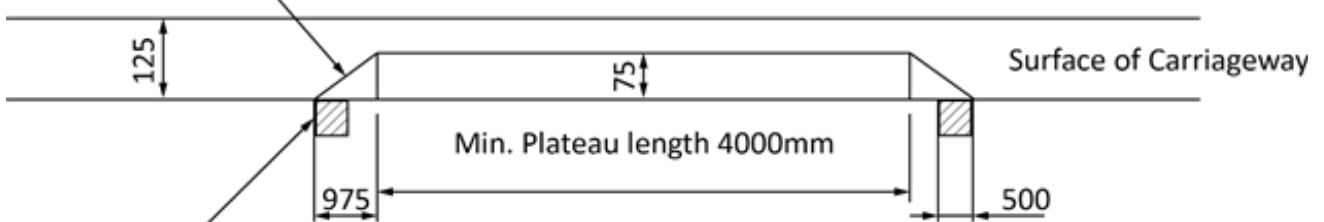

Chase to be cut as shown if speed table is to be constructed after the surface course is laid

Vertical scale exaggerated for illustrative purposes

ADOPTION AND MAINTENANCE

55. The full width of carriageways should normally be offered for adoption as public highway (and any adjacent footway and cycleway).

56. The limits of adoption of new streets shall extend to the edge of the developer's landholding to avoid ransom strips, which make it difficult to achieve well-connected layouts on potential adjacent sites

57. If development streets are to remain private, the LHA will require the applicant to:

- Deposit a map with the LHA under Section 31 (6) of the Highways Act 1980, identifying any routes that are to remain private, including suitable demarcation from those that are to be adopted.

- Provide evidence that the 'unadopted' status of accesses and the practical implications associated with this have been communicated to any potential purchasers of dwellings.
- Provide evidence that future maintenance of accesses/driveways is secured. This may, for example, be a unilateral undertaking by the applicant/ developer under Section 106 of the Town and Country Planning Act to set up a maintenance management company.
- Indemnify the LHA against future petitioning by residents to adopt an access/driveway under Section 37 of the Highways Act 1980, where it connects two adopted streets. Indemnification

DES 06

Carriageways and Vehicle Track Space

shall normally come in the form of a legal covenant placed on the properties to prevent petitioning. The wording of any covenant must be approved by the LHA.

- 4
58. Where the applicant requires highway rights to be extinguished, for example, to stop-up a length of road, this can be achieved under the Town and Country Planning Act 1990. However, agreement must first be sought from the LHA. The applicant will incur all costs associated with this process.
 59. Where any extra areas above that required for the safe functioning of the highway is designated for adoption, the LHA may require a commuted sum for future maintenance.
 60. The LHA will normally require a commuted sum payment for the future maintenance of vertical calming infrastructure.

LINKS AND REFERENCES

- a. This DES should be read in conjunction with Sections 1, 2 and 3 of the Leicester Street Design Guide.

DESIGN ELEMENT SHEET

DES: 07

Subject: Shared Surfaces

Date:	17-05-2019	Version:	0.2
Author:	ANS	Approved:	BD

GENERAL PRINCIPLES

1. The default street type in Leicester shall have a footway adjacent to the carriageway. However, there are some circumstances where a shared surface may be appropriate, particularly on private streets where they do not form part of a public right of way.
2. The Department for Transport published in July 2018 its Inclusive Transport Strategy, the foreword of which called for a "pause [of] the development of shared space schemes while we review and update the Department's guidance".
3. In this context, any designer proposing use of shared surface streets shall discuss and agree the street typology and street typology of the development with the LHA at the earliest opportunity, i.e. at the pre-application discussion stage. The LHA may require developers to engage with local accessibility groups.
4. Nevertheless, this DES provides some design parameters consistent with LSDG that can be used e.g. in private streets or areas that function de facto as shared spaces, i.e. pedestrianised streets in shopping areas that receive occasional vehicles for delivery. These types of street already exist in throughout the city, as set out below under Design Considerations, and developers require guidance to assist with the design of any proposals that affect them or where their application may be appropriate.



The carriageway width on this shared-surface street is proportionate to the built form. The buildings provide the street with a sense of enclosure.

DESIGN CONSIDERATIONS

5. The following types of street can be considered as shared surfaces or shared spaces:
 - Shared private drives in residential developments, where access to a handful of properties is via a shared surface
 - Parking courts, mews streets and off-street parking areas, where slow-moving vehicles will mix with pedestrians
 - Service areas in commercial developments
 - Pedestrianised high streets (or "pedestrian-priority streets") with access for service vehicles or frontagers only, either time-limited, by exemption, or by permit control.
6. These design considerations and the subsequent technical criteria shall be applied in any circumstances where vehicles and pedestrians mix, and not just in the types of environment listed above.

DES 07

Shared Surfaces

7. Where a shared-surface layout is proposed, early discussion with utility providers is essential to help finalise details of the proposed locations for utility equipment based on proposed levels of segregation and service requirements.

TECHNICAL CRITERIA

8. The design speed of shared surface streets shall be 15mph.
9. Unless agreed with the highway authority, shared-surface streets are not appropriate for:
 - Bus routes
 - B1 to B8 land uses, with the exception of B1 use class up to 3,000 m²
10. Shared-surface streets shall normally be considered appropriate where two-way motor traffic flows are below 50 vehicles per hour (DfT Shared Space Project – Stage 1: appraisal of Shared Space. MVA Consultancy, 2009). In residential developments, shared private drives shall serve a maximum of five dwellings.
11. However, there is a general presumption in favour of adopted streets and so shared private drives should only be used where no other access arrangement is feasible.
12. Nevertheless, designers may consider the use of shared private driveways where no other access arrangement is feasible, as follows:
 - Shared private driveways normally give access to five or fewer dwellings and are unadopted.
 - Waste collection must take place from the public highway, so bin stores shall be provided adjacent to the public highway.
 - Private driveways shall preferably have two points of access to avoid the need for a turning area. However, where no other options are deemed feasible, a shared private driveway may be designed as a cul-de-sac. Any necessary measures shall be taken to ensure that parked cars do

not obstruct turning areas, which shall be proved by tracking. If the turning area is not adequate for the turning of a fire appliance, the maximum length of a cul-de-sac shared private drive shall be 20m.

13. Engineered horizontal or vertical traffic calming measures should not normally be necessary. The layout and building form should be the primary tool to control vehicle speeds. However, gateway treatments and incidental features are likely to support the low speed environment on a shared surface street.
14. Where a proposed building fronts directly onto the street, it shall be set back at least 0.5m behind the proposed highway boundary to allow for opening of windows, drainage downpipes, overhanging eaves, etc.
15. The minimum vehicle track space in a shared surface street shall be:
 - 4.25m in a residential shared private drive, up to 5 dwellings
 - 6m in the aisles of car parks and parking courts (unless proved otherwise by tracking, e.g. where one-way circulation allows a narrower aisle)
 - 6m in B1 land use class up to 3,000 m²
 - 7.5m in all other circumstances, subject to tracking; reduced widths to be agreed with the LHA at the pre-application discussion stage.
16. The above widths shall be increased by 0.5m if bounded on one side by a wall, fence or hedge; and 1.0m if bounded on both sides by a wall, fence or hedge.
17. Variable width corridors are considered acceptable providing it can be demonstrated through tracking analysis that swept paths are accommodated and the design encourages drivers to travel at speeds at no more than the design speed.
18. Shared surface streets shall demonstrate

DES 07

Shared Surfaces

compliance with the same requirements as conventional carriageways (DES-6) unless agreed with the LHA.

19. Further guidance on parking courts and off-street parking is set out in DES-16. DES-16 also provides guidance on the interface between private off-street areas and the highway.

ADOPTION AND MAINTENANCE

20. Pedestrian-priority streets and pedestrianised streets shall be adopted by the LHA subject to, inter alia, a Safety Audit as part of a Quality Audit.
21. Guidance on service areas, parking courts and off-street parking is set out in DES-16.
22. Shared private drives shall not be adopted by the LHA.
23. Where shared private drives are proposed, and private streets and vehicle spaces in general, the LHA will require the applicant to:
 - Deposit a map with the LHA under Section 31 (6) of the Highways Act 1980, identifying any routes that are to remain private, including suitable demarcation from those that are to be adopted.
 - Provide evidence that the 'unadopted' status of accesses and the practical implications associated with this have been communicated to any potential purchasers of dwellings.
 - Provide evidence that future maintenance of accesses/driveways is secured. This may, for example, be a unilateral undertaking by the applicant/ developer under Section 106 of the Town and Country Planning Act to set up a maintenance management company.
 - Indemnify the LHA against future petitioning by residents to adopt an access/driveway under Section 37 of the Highways Act 1980, where it connects

two adopted streets. Indemnification shall normally come in the form of a legal covenant placed on the properties to prevent petitioning. The wording of any covenant must be approved by the LHA.

FURTHER INFORMATION

24. Given the DfT's current position (see paragraph 2) and related Inclusive Design research by the DfT with the Scottish Government, the City Council is monitoring the situation and will update this DES as necessary in due course.

LINKS AND REFERENCES

- a. This DES should be read in conjunction with Sections 1, 2 and 3 of the Leicester Street Design Guide.

DESIGN ELEMENT SHEET

DES: 08

Subject: Pedestrian and Cycle Crossings

Date:	17-05-2019	Version:	0.2
Author:	ANS	Approved:	BD

DESIGN CONSIDERATIONS

4

1. The provision of crossing facilities will often be essential to create usable pedestrian and cycle connections linking a development to facilities and services. Crossings are particularly beneficial to disabled and older people as well as to children.
2. Crossings can be uncontrolled, priority controlled (e.g. Zebra crossing) or signal controlled (e.g. Puffin and Toucan) and may also facilitate cyclist and equestrian movements where the need arises.
3. Crossings for cycle traffic will be an important component in ensuring cycle routes offer a fit for purpose user experience. The preference for cycle crossings shall be those where cyclists have default priority or where delay is minimised.
4. Crossings are best placed on the desire line so that they offer the maximum utility.



Toucan crossing, Cambridge



Zebra crossing on a raised table, London

5. The following matters shall be taken into account:
 - Crossings shall be positioned in agreement with the highway authority.
 - Where the design speed exceeds 20mph, it may be necessary to consider some form of controlled crossing such as a Zebra, Parallel Pedestrian and Cycle, Puffin and Toucan to provide safe routes for pedestrians and cyclists. However, for design speeds of 20mph or less, informal crossings are generally likely to suffice unless the street is subject to high vehicular flows.
 - All crossings must include a dropped kerb or carriageway raised to footway level, and may include some form of material change

DES 08

Pedestrian and Cycle Crossings

on the carriageway to give a stronger indication to drivers of the presence of the crossing.

- Visibility at crossings shall be good with the immediate environment kept free from street furniture, parking obstructions, trees and high planting. Build outs may be appropriate solutions to protect visibility in circumstances where this cannot otherwise be avoided.
- The carriageway segment of a crossing facility shall be kept free of any drainage or other infrastructure to ensure the safety of pedestrians when using the crossing, especially visually-impaired people.
- Drainage solutions in the vicinity of the crossing shall be of sufficient quality to ensure that the crossing is kept free of surface water run-off preventing water from 'ponding'.
- The staggering of pedestrian crossings should be avoided. Where crossing in two stages is unavoidable, the pedestrian desire line can be maintained by provided two crossings in line with each other but separated by a wide central refuge island, or subject to a Road Safety Audit as part of a comprehensive Quality Audit. Examples of these are Preston (4.5m at Ringway / Friargate) and Nottingham (6m, Maid Marian Way / Friar Lane) and Plymouth (8m, Cobourg Street / Eastlake Street)
- All formal crossings must include tactile paving. Refer to the latest version of DfT Guidance on the use of Tactile Paving Surfaces.
- Tighter corner radii at junctions are desirable to ensure that crossings can follow desire lines and vehicle speeds are controlled. This will be subject to tracking analysis demonstrating that the swept path tracking manoeuvre can be

accommodated. See the Carriageways and Vehicle Track Space DES.

- Crossings may be used in conjunction with speed calming measures. Narrowing is particularly effective because the build out of the footway into the carriageway shortens the crossing distance for pedestrians. Similarly, raised tables, including side road entry treatments, can be effective in denoting changes in street character or inferring shared priority, particularly at junctions.
- The use of guard railing shall normally be avoided, but may be relevant in certain areas e.g. outside schools or subject to a
- Road Safety Audit as part of a comprehensive Quality Audit.
- Separate crossings for pedestrians and cyclists can be provided for both priority (Parallel Crossing) and signal-controlled situations.



Water 'ponding' at a controlled crossing due to poor design and detailing of drainage.

DES 08

Pedestrian and Cycle Crossings



Parallel cycle-zebra crossing on raised table, Hackney



Directly-aligned two-stage pedestrian crossing at Maid Marian Way, Nottingham

TECHNICAL CRITERIA

6. Crossings shall be planned and designed consistent with recommended practices as described by 'The Design of Pedestrian Crossings Local Transport Note 2/95'. This is particularly important to ensure items of traffic signal equipment integrate elements such as audible beeps and rotating cones to respond to the needs of disabled users.
7. Traffic signs at formal crossings must comply with TSRGD 2016.
8. Formal crossings shall normally be designed and constructed in accordance with the LHA standard drawings.

9. For further guidance on traffic signals, refer to DES-11.
10. For tactile paving guidance refer to the latest version of the DfT Guidance on the Use of Tactile Surfaces.
11. Where a refuge in the middle of the carriageway is required, this shall be provided to standard drawings with:
 - 2.0m - width for pedestrian-only use
 - 2.5m - width if used by cyclists
 - 3.2m - clearance to the carriageway on either side of the refuge
12. Where there is a footway on the opposite side of the street to a bus stop, a crossing facility shall be provided as close as possible to the bus stop to facilitate access, bearing in mind safety considerations.
13. Where a new junction is formed between a bridleway and public highway, an equestrian traffic crossing facility (Pegasus crossing) shall be provided for horse riders (refer to LTN 2/95 for further information).
14. In car parks, safe pedestrian and cycle routes shall be provided which follow desire lines wherever possible.

ADOPTION AND MAINTENANCE

15. Formal crossings required on new and existing streets as a consequence of development proposals shall attract a commuted sum for future maintenance.

LINKS AND REFERENCES

- a. DfT Guidance on Inclusive Mobility.
- b. The Design of Pedestrian Crossings Local Transport Note 2/95.
- c. For further guidance on tactile paving design, refer to the latest version of DfT Guidance on the use of Tactile Paving Surfaces.
- d. This DES should be read in conjunction with Sections 1, 2 and 3 of the Leicester Street Design Guide.

DES 09

Junctions: Priority, Unmarked and Informal Junctions



DESIGN ELEMENT SHEET

DES: 09

Subject: Junctions: Priority, Unmarked and Informal Junctions

Date:	17-05-2019	Version:	0.2
Author:	ANS	Approved:	BD

DESIGN CONSIDERATIONS

1. These forms of junction represent the simplest configuration of interaction between conflicting movements, and generally the most legible for all.
2. There shall be an emphasis on making junctions as simple as possible so that all users can understand them and therefore most junctions in new developments will be T-junctions, crossroads or staggered junctions.
3. Junctions can take different forms however, informed by the local context and to create and may be used to create and emphasise important locations within a development.
4. Junctions can be marked to indicate which arms have priority but on quieter streets or where the priority is clear from the street hierarchy it will normally be appropriate to leave them unmarked. Distinction can be further reduced to create informal junctions.



Shared surface junction in residential area.

5. The following matters shall be taken into account in designing the location and arrangement of all types of junctions:
 - Corner radii should be minimized to reduce vehicle speeds and create safer conditions for pedestrians and cyclists; see Figure 9.2 and Table 9.3.
 - Junctions can be used as an effective speed control measure to break-up otherwise straight or nearly straight sections of carriageway; see Figure 9.1.
 - The spacing of junctions should generally be based on the type and size of urban blocks appropriate for the development. It will not normally be necessary to separate lightly-trafficked junctions on the same side of the street by a distance equivalent to the Stopping Sight Distance.
 - Simple junctions on opposite sides of the street should either be arranged to form



Informal junction in low-traffic retail area

DES 09

Junctions: Priority, Unmarked and Informal Junctions

crossroads or should be staggered by at least a carriageway width.

- Junctions shall normally be designed so to allow any larger vehicles that may regularly use the street, such as refuse vehicles, to negotiate them without any need to overrun the footway. This consideration extends to managing the approach and exit environment of the junction, particularly where parking is likely to coexist in the vicinity, to ensure that any issues that may compromise the safe and efficient function of the junction are mitigated
 - Junctions shall not be designed to not require vehicles to overrun the footway. Parking controls may be required to achieve this.
 - Over-run protection, e.g. bollards, will attract a commuted sum.
 - The suitability of corner radii and carriageway widths at junctions shall be based on tracking assessments using the largest regular vehicle. This assessment must include checks for refuse vehicles, a fire tender and, if appropriate, a bus. Tracking assessments shall include any on-street parking provided or likely to occur.
 - Corner radii shall normally be kept free of any private accesses.
 - Junctions may be tabled in their entirety or across the minor arm to reduce traffic speeds; see the technical criteria below and DES-06.
 - Bus stops located in the vicinity of junctions shall be set back from the junction so as not to adversely impact on operability and safety. Refer to DES-05 for further information on bus stop design
6. The following matters shall be taken into account when considering informal junctions:
- Informal junctions work best where the physical layout leads motorists to proceed cautiously, and negotiate with other road users
 - Informal junctions generally work best where there are high volumes of pedestrian activity. Informal junctions have also been shown to work on four arm junctions and those with peak flows in excess of 2,500 vehicles per hour.
 - The suitability of a location for an informal junction shall be agreed with the highway authority at the outset of the design process.
 - Pedestrian safety shall be the primary consideration in the design of an informal junction and the determination of its suitability.
 - Vehicular paths shall be limited to a single lane on entries and exits which shall be kept relatively narrow.
 - The design of informal junctions required Development Team consideration as they often need to respond to the context and respective vehicular and pedestrian demands placed upon them. A Road Safety Audit as part of a more comprehensive Quality Audit will be required.
 - The form and layout of the junction shall respectfully consider the user hierarchy priority which shall place emphasis on pedestrian and vulnerable users. An example of an informal junction that would be unacceptable in a residential context is traffic signalling which may be perceived as inferring priority to the motorist.
 - Informal junctions may include formal or informal pedestrian crossing facilities in accordance with pedestrian desire lines. Zebra crossings may be appropriate at busy or large junctions.
 - Where crossings are provided, the material used for the crossing shall contrast in colour and texture to that used for the

DES 09

Junctions: Priority, Unmarked and Informal Junctions

general carriageway. Materials other than standard bituminous surfacing shall generally be used with an objective of enhancing the sense of place and enhancing the visibility of the junction, particularly for the vehicles travelling along the carriageway.

- Explicit consideration must be given to the needs of visually-impaired users who may find informal features challenging to navigate.
- Tactile paving shall be installed where required by Department for Transport guidance.

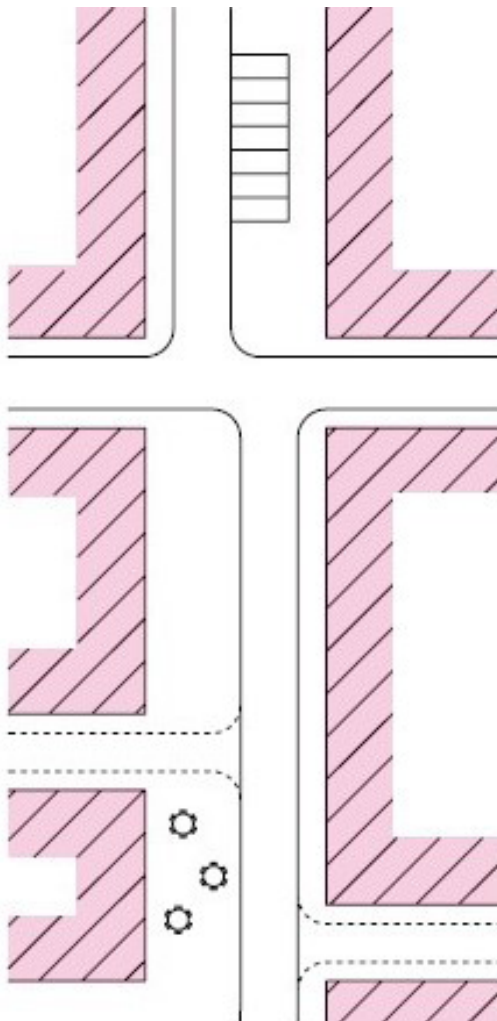

Figure 9.1 – junction offset as speed control

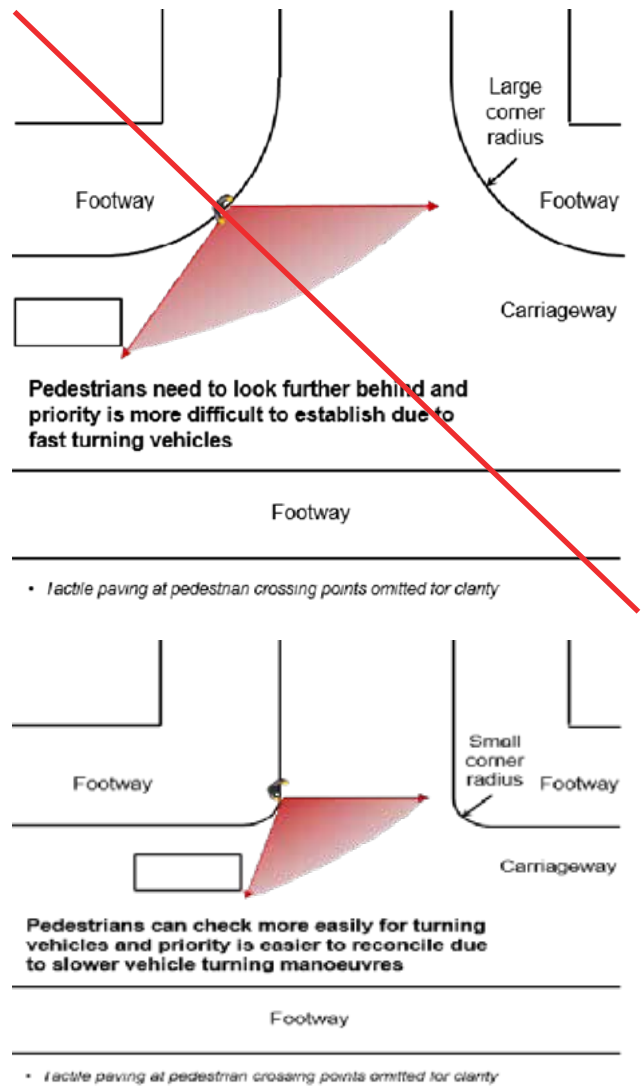

Figure 9.2 – tighter junction radii not only reduce turning speed, but narrow the area pedestrians need to visually check before crossing a side road.

DES 09

Junctions: Priority, Unmarked and Informal Junctions

4

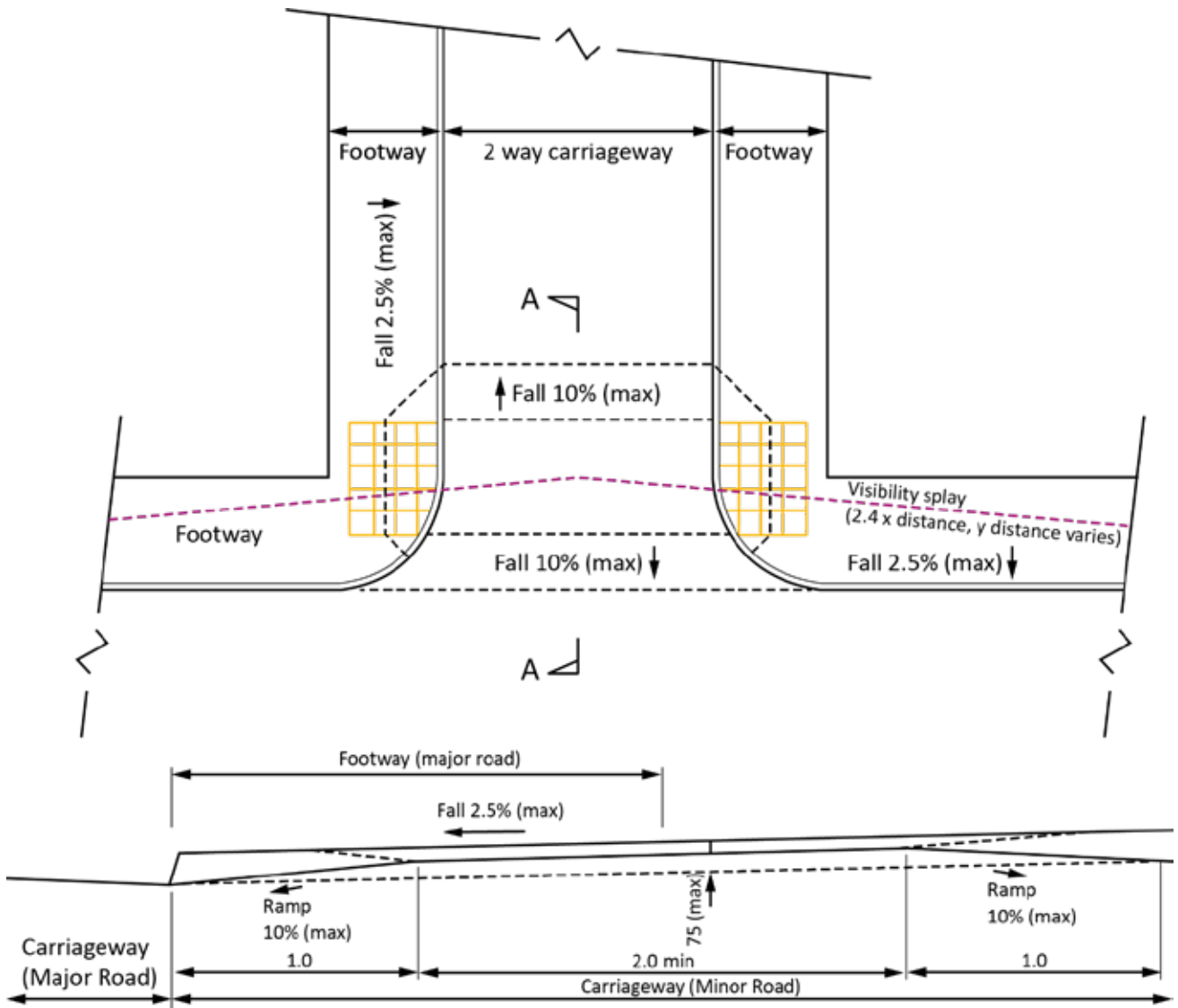

Fig 9.4 – Side Road Entry Treatment typical detail in plan and profile view

DES 09

Junctions: Priority, Unmarked and Informal Junctions

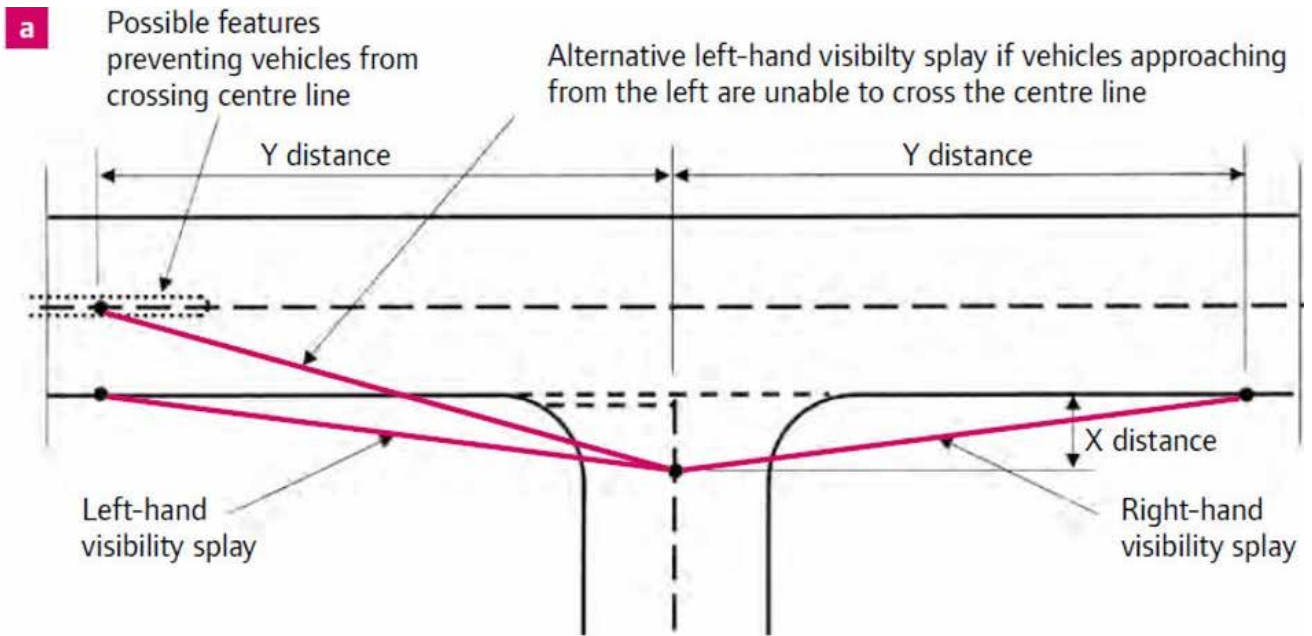

Fig 9.5 – Visibility splay construction at a simple, rectilinear priority junction

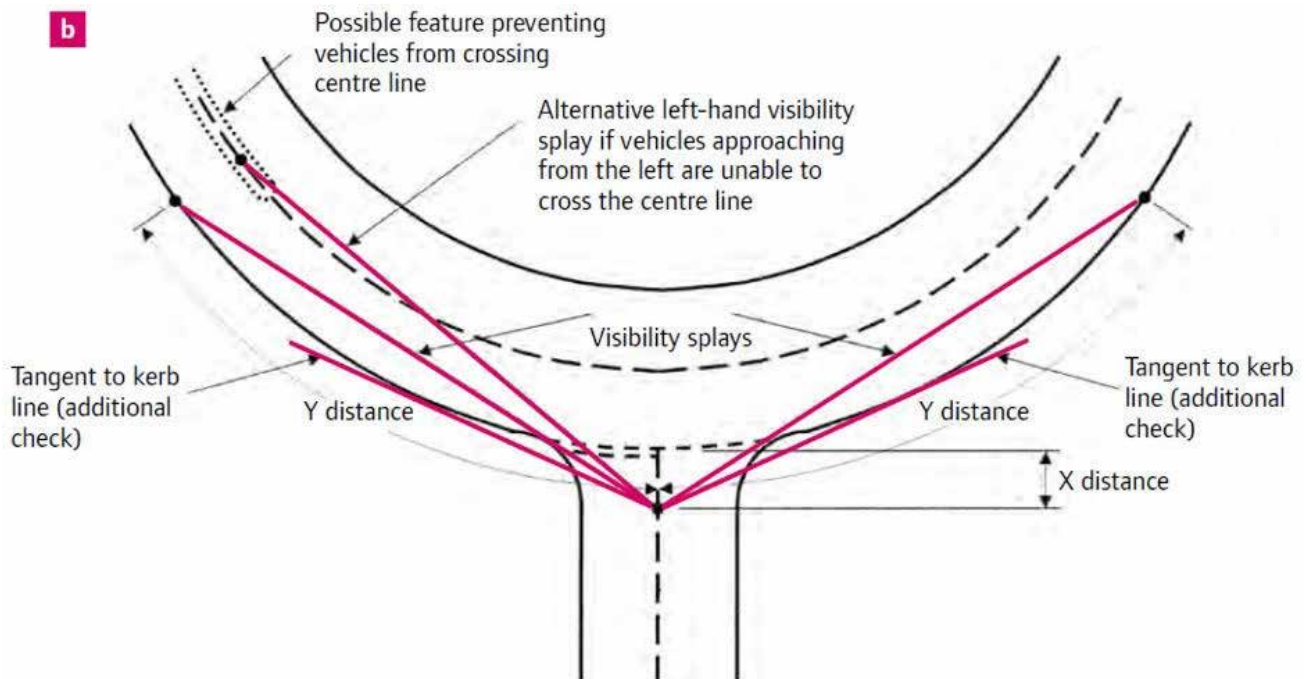

Fig 9.6 – Visibility splay construction at a priority junction on the outside of a bend

DES 09

Junctions: Priority, Unmarked and Informal Junctions

4

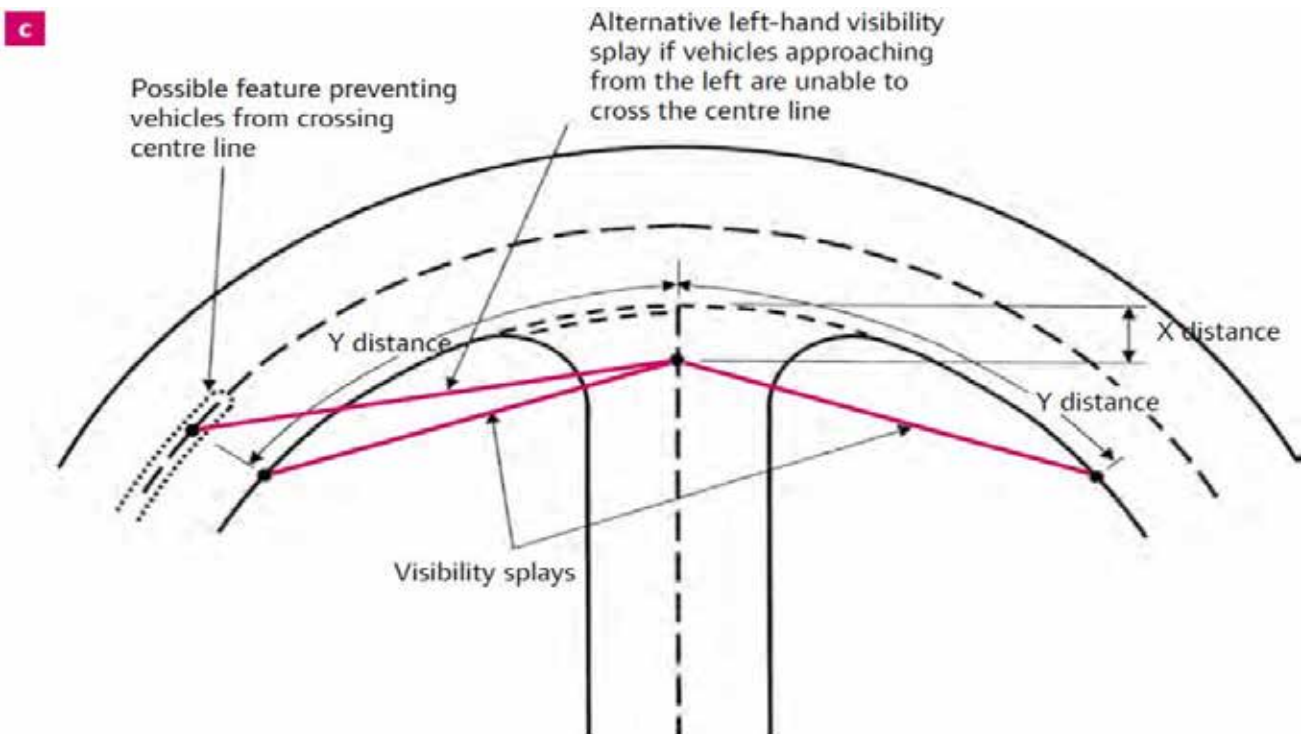

Fig 9.7 – Visibility splay construction at a junction on the inside of a bend

TECHNICAL CRITERIA

DESIGN SPEED AND SPEED CONTROL

7. The maximum design speed for informal junctions shall be 20 mph.
8. Speed control may be achieved by minimising corner radii, subject to satisfactory proof of vehicle tracking and compliance with the minima set out in table 9.3 opposite.
9. Side Road Entry Treatments across the minor arm of junctions may be used on all routes where the side street traffic flows are less than 300 vehicles per hour. A typical detail of a Side Road Entry Treatment is shown in Figure 9.4 below. Vertical deflection and ramp gradient parameters shall comply with the requirements set out in DES-06.
10. Measures may be required to prevent vehicles using raised tables to mount the footway. These will attract commuted sums.

GEOMETRY

11. Minimum corner radii at junctions shall depend on traffic speed on the major arm and traffic flow on the minor arm, as set out in Table 9.3 opposite. However, tracking will be required to prove the accessibility of any junction.

Table 9.3 – Minimum corner radii

Major arm speed (85th percentile or design speed)	Average 2-way peak hour traffic flow on minor arm (PCU)	Minimum corner radius
<20mph	<100vph	-
20mph	<100vph	-
	>100vph	2m
30mph	<50vph	-
	50-300vph	3m
	>300vph	6m

DES 09

Junctions: Priority, Unmarked and Informal Junctions

12. The longitudinal gradient for the first 10m of any arm off a junction shall be 1:30 or less.
13. Crossroads are acceptable in the following situations:
 - On 20mph and below streets when the average peak hour two-way flow on any arm of the junction is less than 100 vehicles per hour.
 - On 30mph streets where the side arms are designed to 20mph and below and when the average peak hour two-way flow on the busiest minor arm is less than 50 vehicles per hour.
14. Basic junction forms shall be determined at an early point of the design development stage with more detailed proposals developed as the design evolves.
15. Tracking assessments of vehicle swept paths will need to be provided to validate junction operability.
19. Splays shall be measured to the kerb line, although a more accurate assessment of visibility splay is made by measuring to the nearside edge of the vehicle track and may be used as an alternative
20. Visibility splays shall generally be kept free from obstacles that restrict visibility. Obstacles that do not restrict visibility significantly may be acceptable such as trees with narrow trunks.

ADOPTION AND MAINTENANCE

21. Vertical deflection traffic calming measures shall attract a commuted sum if offered for adoption.
22. Bollards to prevent vehicle incursion at junctions and raised entry treatments shall attract a commuted sum if offered for adoption.

LINKS AND REFERENCES

- a. For guidance on designing pedestrian crossing points, refer to DES-03. For guidance on designing for cyclists at junctions, refer to DES-04. For guidance on SSDs, refer to DES-06.
- b. For guidance on tactile paving design, refer to the latest version of DfT Guidance on the use of Tactile Paving Surfaces.
- c. For further information on Quality Audits, refer to DfT (2011), Traffic Advisory Leaflet 05/11 'Quality audit in the street design process'.
- d. This DES should be read in conjunction with Sections 1, 2 and 3 of the Leicester Street Design Guide.

VISIBILITY

16. The visibility splay at a junction ensures that there is appropriate inter-visibility between major and minor arms necessary for the safe and efficient operation of the junction.
17. Visibility at junctions shall be calculated from a position set-back 2.4m from the give way line of the minor arm or from the equivalent unmarked position (known as the 'X' distance). This can either be calculated from the centreline of the minor arm, or from the likely position of the driver. If the junction contains a wide splitter island on the minor arm, the latter may be more appropriate.
18. The 'Y' distance' (see figures 9.5 to 9.7 above) is the distance at which the driver –positioned on the minor arm –is required to see along the major arm in both directions. In the majority of cases, the value of the 'Y' distance is expected to be based on the SSD value for the respective arm as set out in DES-06.

DES 10

Junctions: Roundabouts



DESIGN ELEMENT SHEET

DES: 10

Subject: Junctions: Roundabouts

Date:	17-05-2019	Version:	0.2
Author:	ANS	Approved:	BD

DESIGN CONSIDERATIONS

4

1. There are various types of roundabouts, including compact, normal, signalised and mini roundabouts.
2. The choice of roundabout is dependent on a number of connected factors including speed limits, levels of traffic, land-take constraints and levels of non-motorised users.
3. Roundabouts will not be normally required within most residential streets that are designed using this guide. However, there may be instances where compact roundabouts or three-arm mini-roundabouts with good speed reduction facilities are considered acceptable to provide an access from an existing highway into a development site. They are not usually acceptable, however, unless considered as part of a comprehensive traffic calming scheme.



Standard mini-roundabout with overrun areas.



Standard mini-roundabout with textured surfacing

4. The following matters shall be taken into account:
 - Mini-roundabouts can be designed to be either flush or domed. Where domed, alternative materials may be used.
 - Flush mini-roundabouts tend to work better where traffic flows are relatively high, well balanced on all arms, and on bus routes.
 - For mini-roundabouts to work effectively, traffic flows shall be reasonably balanced between arms. Ideally, the minor arm flow shall not be lower than 10-15% of the major arm flow. Where the minor arm flow is too low, the major arm will operate under free-flow conditions.
 - Domed variants may be preferable where traffic flows are low and/or where flows are less well balanced, but remain above the 10% threshold, or where subtle topographical variances have the potential to lead to forward visibility issues.

DES 10

Junctions: Roundabouts

- Doming has been shown to have a higher calming effect on speeds as well as encouraging motorists to travel around and not directly over the central island. However, it is also more likely to encourage motorists to travel anti-clockwise at the junction where excess visibility to other arms exists.
- The use of other speed control features and/or crossing facilities in the vicinity can complement the operation of mini-roundabouts in certain circumstances. Attention must be given to the adoption of inclusive design principles.
- Mini roundabouts with four or more arms shall not be accepted.

TECHNICAL CRITERIA

5. 125mm - maximum height for a domed mini-roundabout. The height shall preferably be lower on bus routes.
6. Double mini-roundabout designs or other junction types shall be used where four or more arms exist.
7. The position of the central island shall be informed by a tracking assessment. This shall include the largest likely specification of vehicle (e.g. refuse vehicle, pantechicon and/or bus). Where domed, vehicles will need to pass around the central island; however, where a flush central island is used, large vehicles may pass over the island, but must not encroach to the other side.
8. Designers must be able to demonstrate that flows are 'reasonably balanced' where proposing a mini- roundabout across at least three arms.
9. Tracking assessments will need to be provided to validate the safe and successful operation of mini-roundabouts.

LINKS AND REFERENCES

- a. For further guidance on the design of mini- roundabouts, refer to Department for Transport (DfT) mini-roundabouts good practice guidance.
- b. For guidance on signage and street markings regarding roundabouts and mini-roundabouts, refer to TSRGD 2016.
- c. For guidance on crossings and tactile paving, refer to DES-08 and the latest version of DfT Guidance on the use of Tactile Paving Surfaces respectively.
- d. This DES should be read in conjunction with Sections 1, 2 and 3 of the Leicester Street Design Guide.
- e. See also DES-06 for guidance on vehicle tracking requirements.

DES 11

Junctions: Traffic Signals



DESIGN ELEMENT SHEET

DES: 11

Subject: Junctions: Traffic Signals

Date:	17-05-2019	Version:	0.2
Author:	ANS	Approved:	BD

DESIGN CONSIDERATIONS

TRAFFIC SIGNAL EQUIPMENT

4

1. The need for new traffic signal installation will normally be as a result of the Transport Assessment undertaken as part of a development's planning application.
2. Traffic signals may also be required by the Local Highway Authority as a condition of a development's planning consent.
3. During construction, the applicant must allow the LHA access to any part of the site at which cables, pipes, ducts or other traffic-signal apparatus are located at all reasonable hours in order carry out installation and maintenance works.
4. Traffic signals will not be normally required within most of the residential streets that are designed using this guide. However, there may be instances where traffic signals are used to form the principal access to sites, establish bus or cyclist priority and/or provide controlled pedestrian crossings.
 - Traffic signals shall normally only be used to control movement once urban design and street layout solutions have been discounted.
 - Traffic flows may dictate the need for traffic signals, which will be agreed by the Local Authority during the development design process.
 - Equipment associated with traffic signalling can clutter the street environment and hence there is a preference for use only where there is a specific objective to

be achieved for which traffic signalling provides the most appropriate answer.

- Pedestrian control positions shall be suitable in relation to the kerb and the direction of traffic to enable users to remain alert of any hazards.
- Pushbuttons shall normally be mounted at 45° to the kerb on poles.
- Traffic signal equipment at crossings must be planned and constructed consistent with recommended practices as described by 'The Design of Pedestrian Crossings Local Transport Note 2/95'. This is particularly important in ensuring that traffic signal equipment integrates important components (audible beepers, tactile rotating cones, etc.) to respond to the needs of disabled users.
- Tactile rotating cones shall be fitted to all signal controlled crossings.



Pedestrian crossing facility at a junction.

DES 11

Junctions: Traffic Signals

ADOPTION AND MAINTENANCE

5. The applicant will be expected to pay the relevant LHA for the reasonable cost of design, supply and installation of traffic signal equipment.
6. A commuted sum is required for traffic signals to cover future maintenance.

CHECKLISTS

7. If proposing traffic signals as a means of establishing bus priority, bus operators shall also be consulted on proposals.

LINKS AND REFERENCES

- a. This DES should be read in conjunction with Sections 1, 2 and 3 of the Leicester Street Design Guide.
- b. For guidance on traffic control system design, refer to Highways England TR2500.
- c. For guidance on the installation of traffic signalling equipment, refer to LTN 1/98: The Installation of Traffic Signals and Associated Equipment.
- d. For guidance on audible beepers, refer to DfT Traffic Advisory Leaflets 4/91.
- e. For information on the use of Selective Vehicle Detection (SVD) technology in London, see TfL's brochure 'Bus Priority at Traffic Signals keeps London Buses Moving'.



DESIGN ELEMENT SHEET

DES: 12

Subject: Signs, Markings and Regulations

Date:	17-05-2019	Version:	0.2
Author:	ANS	Approved:	BD

DESIGN CONSIDERATIONS

TRAFFIC SIGNS AND LINES

4

1. The applicant is required to provide all street markings and traffic signs on both the internal street network and any sections of external highway that are considered necessary. Occasionally, this may involve signing at some distance from the development, e.g. for HGV routing.
2. On larger developments, it may be necessary to provide on and off-site direction signs and markings for wayfinding in order to enable people to use the street network effectively.
3. At site accesses and for all streets serving commercial or employment uses with the exception of B1 office uses, lining and signing shall be provided in accordance with TSRGD 2016. Large areas of thermoplastic road markings shall be avoided in the interests of aesthetics and road safety. The latter is particularly important for motorcyclists usually within steering, braking and accelerating areas, as grip and vehicle stability can be adversely affected.
4. Lining and signing will not normally be required on the internal street network for residential or B1 office use classes. It is advisable to contact the LHA for further information in case local circumstances dictate otherwise.
5. Any signs erected on vertical poles (as well as any other items oversailing the footway) must have a minimum height clearance of 2.3m. If such signs are low-level, designs shall include a lower tapping rail or skirting linking the posts to prevent visually-impaired people from walking into them. The rail or skirting shall be between 300-400mm from ground level, while the sign itself shall not extend more than 150mm beyond the supporting posts.
6. Where parking bays are not otherwise defined by a change in materials, it is normally expected that appropriate road markings will be used.
7. All traffic signs (including bollards, retro-reflecting studs and markings) shall be to the size, shape, colour and type set out in TSRGD 2016.
8. For traffic signs and lines pertaining to pedestrian and cycle crossings, the applicant shall normally follow TSRGD 2016. Where studs are required at crossings, metal road studs shall be avoided as they can cause problems to two-wheeled vehicles.
9. The details of individual traffic signs including their posts and foundations shall be presented in sign schedule in a format agreed by the highway authority. A commuted sum is payable towards the long-term maintenance cost.
10. Where creating a permanent alteration to the original road or street layout, a sign to diagram 7014 of TSRGD 2016 will normally be required on all approaches to the altered layout. It shall be provided immediately upon implementing the alteration and remain in place for a period of three months. The applicant is typically responsible for maintaining these signs for this period and for ensuring their removal at the period's conclusion.

DES 12

Signs, Markings and Regulations

ILLUMINATED TRAFFIC SIGNS

11. In some circumstances, illuminated signs may be required in order to meet the requirements of TSRGD 2016.
12. Most illuminated signs are fed by an electricity company supply. However, certain signs must be fed by a private highway authority supply, and in some situations solar panels may be appropriate.
13. The location and details of all signs and bollards that require illumination are to be detailed on a layout plan to allow the LHA to identify electricity supply requirements. These requirements are normally incorporated within the street lighting design. Subsequently, the applicant is normally required to:
 - Arrange for electricity supply if required (irrespective of source).
 - Provide test certificates in accordance with BS7671.
 - Take responsibility for all aspects of the works including energy charges, maintenance and 'bulk clean and lamp change' in advance of issue of the final certificate. The cost of 'bulk clean and lamp change' will be provided in the bond figure.

BOLLARDS

14. All bollards (including vertical posts) will require a commuted sum for long term future maintenance and shall as far as is reasonably practicable:
 - Take into account the needs of all street users and consider whether such features are required.
 - Be positioned to allow at least the minimum footway width (see Footways and Footpaths DES) between them.
 - Be at least 1m in height.
 - Be clearly visible and remain conspicuous

in dark and bad weather conditions, by being a colour that contrasts with the wider street environment and/or including bands that contrast in colour to the rest of the bollard/post at a band depth of 150mm. The top of any bollards shall be coloured likewise. Grey tends to be the least effective colour as it fails to contrast with the carriageway and footway in a typical street environment.

- Under no circumstances be linked with chain, rope or similar.
15. The applicant is required to apply to the City Council to commence street naming proceedings. The council will then advise of any further details required of the applicant. Once street names have been decided, the applicant will normally be responsible for erecting the name plates. Any name plates on unadopted streets or private driveways shall clearly state the street/driveway is either 'unadopted' or 'private'.

PRIVATE ROADS AND STOPPING UP

16. Where the applicant requires highway rights to be extinguished, for example, to stop-up a length of road, this can be achieved under the Town and Country Planning Act 1990. However, agreement must first be sought from the LHA. The applicant will incur all costs associated with this process.
17. Where private streets are proposed, the LHA will require the applicant to:
 - Deposit a map with the LHA under Section 31 (6) of the Highways Act 1980, identifying any routes that are to remain private, including suitable demarcation from those that are to be adopted.
 - Provide evidence that the 'unadopted' status of accesses and the practical implications associated with this have been communicated to any potential purchasers of dwellings.

DES 12

Signs, Markings and Regulations

4

- Provide evidence that future maintenance of accesses/driveways is secured. This may, for example, be a unilateral undertaking by the applicant/ developer under Section 106 of the Town and Country Planning Act to set up a maintenance management company.
- Indemnify the LHA against future petitioning by residents to adopt an access/driveway under Section 37 of the Highways Act 1980, where it connects two adopted streets. Indemnification shall normally come in the form of a legal covenant placed on the properties to prevent petitioning. The wording of any covenant must be approved by the LHA.

TRAFFIC REGULATION ORDERS

18. Where a development requires changes to an existing Traffic Regulation Order (TRO) or where a new order is required, the applicant is required to pay all associated costs including consultation and legal costs. The applicant shall seek advice from the LHA on likely timescales involved with such proposals and factor these into their work programme.

ADOPTION AND MAINTENANCE

19. A commuted sum is payable towards the long-term maintenance cost of:
- Name plates.
 - Signs.
 - Bollards.

LINKS AND REFERENCES

- a. This DES should be read in conjunction with Sections 1, 2 and 3 of the Leicester Street Design Guide.



DESIGN ELEMENT SHEET

DES: 13

Subject: Highway Structures

Date:	17-05-2019	Version:	0.2
Author:	ANS	Approved:	BD

DESIGN CONSIDERATIONS

TRAFFIC SIGNS AND LINES

1. There are three broad types of highway-related structures:

- Any structure built in, under, or over the highway.
- Any retaining wall built within 3.65m of the highway boundary where the retained height above the adjacent highway is 1.4m or more. See Figure 13.1.
- Any retaining wall or structure which supports the highway and where the distance between the highway boundary and the rear face of the wall or structure (W) is less than twice the difference in level (L) between the ground at the front of the wall and the highest level of the adjacent highway at any point along the length of the wall or structure. See Figure 13.2.

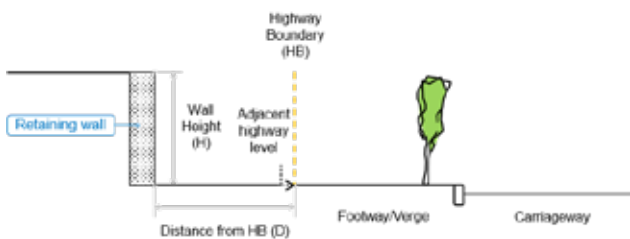

Retaining wall is a highway structure if $D \leq 3.65m$ and $H \geq 1.4m$

Figure 13.1. Defining highway-related structures / Example: Retaining wall A (For illustrative purpose only)

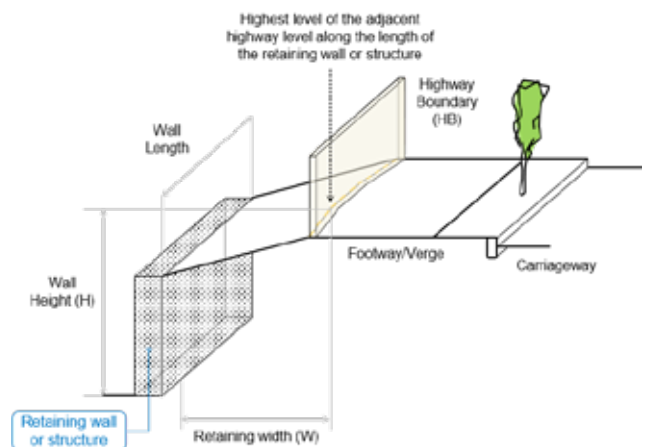

Retaining wall or structure is a highway structure if $W < 2H$

Figure 13.2. Defining highway-related structures / Example: Retaining wall B (For illustrative purpose only)

2. Highway-related structures, as considered within the City of Leicester, normally include:

- Bridges.
- Fences (including safety fences).
- Retaining walls.
- Corrugated-steel buried structures.
- Reinforced soil and anchored earth structures.
- Reinforced clay brickwork retaining walls of pocket-type and grouted-cavity construction.
- Crib wall retaining walls of concrete or timber construction.
- Environmental barriers (including noise fencing).

DES 13

Highway Structures

4

- All drains, pipes and box culverts, sewers and drainage structures, other than bridges, that have a diameter or clear span of more than 900mm.
3. All highway-related structures, whether to be adopted or not, shall be designed and constructed in accordance with current relevant Highways England standards, codes of practice and technical memoranda unless agreed otherwise. Design is normally subject to the technical approval procedure set out in BD 2/12 within DMRB and in the context of this design guide, the technical approval authority is the relevant LHA. The applicant must employ a qualified civil or structural engineer with experience in highway structures, with approval from the relevant LHA, to carry out design and oversee construction.
 4. Prior to construction, the applicant shall provide the LHA with a programme of supervision for approval. This programme shall give details of the level and amount of supervision provided and contain proposals for materials testing. The works will then be audited by the LHA at regular intervals for compliance with the construction programme.
 5. Prior to the request for a full adoption certificate, the applicant shall provide the LHA with the following pieces of information:
 - Copies of approved calculations (if not already received).
 - Inspection certificates.
 - Material testing certificates.
 - Digital photographs on CD (.jpg or .bmp format).
 - As-built drawings on CD (e.g. an AutoCAD file).
 - Maintenance manuals.
 - Health and Safety File.
 - Construction compliance certificate (in accordance with Annex C6 of BD 2/05 of DRMB).
 6. The applicant is normally required to pay the additional design checking and inspection fees for any highway structure to be charged at 'actual' rates. The LHA will provide an indication of the likely fee at the earliest possible opportunity.

SAFETY FENCING

7. Safety fencing shall not generally be required within residential developments because the need shall be designed out by providing layouts that are safe for people to live in. Where safety fencing is unavoidable in a residential area, or required to address existing situations where problems exist or circumstances have changed, then reference shall be made to RRRAP (Road Restraint Risk Assessment Process) contained in TD 19/06 where flows are appropriate.
8. In the event that flows are not sufficient to meet the thresholds in this guidance then an individual risk assessment shall be made in conjunction with a Road Safety Audit. Care shall be taken to avoid the use of safety fencing to protect users from the dangers of other objects or hazards within the highway boundary by first determining whether the objects in question could be relocated to remove the hazard.
9. Safety fences and barriers must comply with Section 2 of Highway Construction Details published by Her Majesty's Stationery Office as Volume 3 of Highways England's Manual of Contract Documents for Highway Works.

NOISE FENCING

10. Unless agreed otherwise, noise fencing shall be treated as a highway structure. As such, it must meet the design requirements for a structure. Design checking fees and a commuted sum payment for future maintenance are normally required for noise fencing.

DES 13

Highway Structures

ADOPTION AND MAINTENANCE

11. A commuted sum is payable towards the long-term maintenance cost of:

- Structures.
- Safety fencing.

LINKS AND REFERENCES

- a. Highway Construction Details, Vol 3 of Highways England MCHW.
- b. Design Manual for Roads and Bridges:
 - BD 2/05
 - BD 2/12
 - TD 19/06
- c. This DES should be read in conjunction with Sections 1, 2 and 3 of the Leicester Street Design Guide.

DESIGN ELEMENT SHEET

DES: 14

Subject: Cycle Parking

Date:	17-05-2019	Version:	0.2
Author:	ANS	Approved:	BD

DESIGN CONSIDERATIONS

TRAFFIC SIGNS AND LINES

4

1. The provision of well-designed cycle parking is essential to support the increase take-up of cycling as a practical transport choice. Suitable cycle parking shall therefore be provided for all types of development where required by the Leicester City Council Vehicle Parking Standards Supplementary Planning Guidance.
2. Where required in residential developments, cycle parking shall be:
 - Covered, well-lit and secure, with access for residents only
 - Well located: close to the entrance of the property and avoiding obstacles such as stairs, multiple doors, narrow doorways (less than 1.2 metres wide) and tight corners.



Cycle parking shelter



Residential sheltered cycle parking at a residential development

3. In non-residential developments secure and covered cycle parking will be required for employees, together with short-stay cycle parking spaces in the public realm for visitors.
4. Communal workplace cycle parking facilities shall be:
 - provided with stands/racks allowing both the frame and at least one wheel to be secured.
 - located inside buildings, or outside in locations where they enjoy good light and observation from their surroundings. Larger facilities will normally require dedicated lighting.
 - managed in order for access to be administered and to provide ongoing maintenance of the facility.

DES 14

Cycle Parking

5. Short stay visitor cycle parking shall be sited so as not to inconvenience pedestrians or cause obstructions for visually-impaired people using the footway. This will normally be provided in the form of 'Sheffield' D-type style stands.
6. D-stands shall be orientated perpendicular to any slope, and when constructed as a 'toast rack' (i.e. multiple provisions of D-stands), they shall normally be laid out in echelons to minimise overhang into pedestrian desire lines. Crossbars can be added to 'D' stands to make them more suitable for step-through cycle frames and children's cycles and to provide a tapping rail for the benefit of visually impaired people.
7. In the public realm (such as a high street), small clusters of public cycle parking facilities are generally preferred over large, consolidated ones. Larger facilities may be appropriate to service a particular destination land use, however e.g. a railway station or a hospital.



Communal residential cycle parking

DES 14
Cycle Parking

4

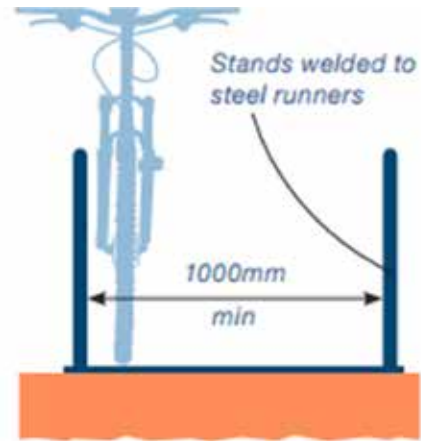
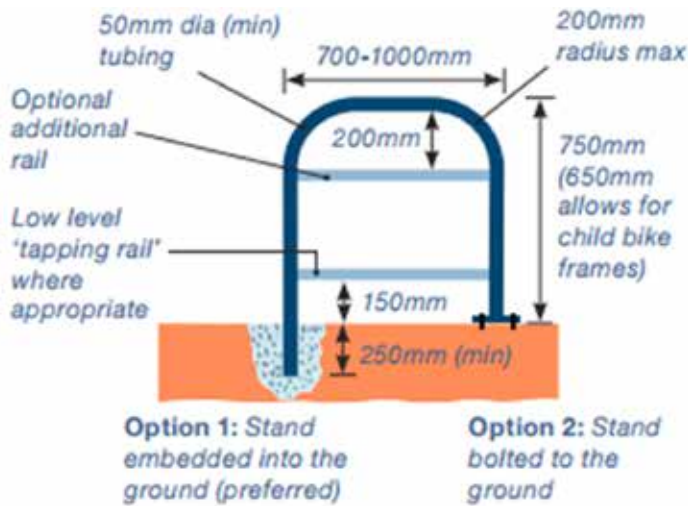

Layouts

Perpendicular

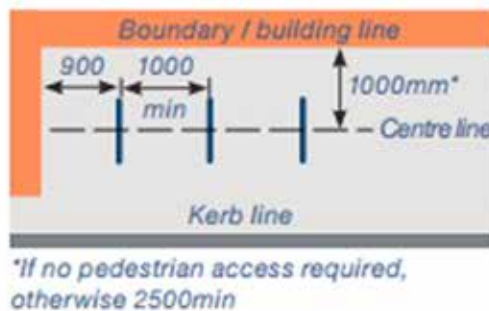

Along kerb

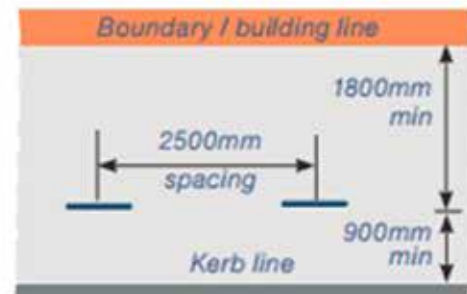

D-stand design (from Sustrans Handbook for Cycle-Friendly Design)

TECHNICAL CRITERIA

QUANTITY OF CYCLE PARKING PROVISION

8. The number of cycle parking spaces provided in new developments shall be in accordance with Leicester City Council Supplementary Planning Guidance: Vehicle Parking Standards.

LOCATION CRITERIA

9. 20m - preferred maximum distance from building entrance to which it serves.

LINKS AND REFERENCES

- a. For further information, refer to:
 - Sustrans Design Manual.
 - London Cycling Design Standards - Chapter 4.
 - Wales Active Travel Design Guidance - Chapter 6.
- b. For further information on cycle infrastructure see DES-04 and DES-08.
- c. This DES should be read in conjunction with Sections 1, 2 and 3 of the Leicester Street Design Guide.



DESIGN ELEMENT SHEET

DES: 15

Subject: Motorcycle Parking

Date:	17-05-2019	Version:	0.2
Author:	ANS	Approved:	BD

GENERAL

1. Minimum provision of motorcycle is set out in the Leicester Vehicle Parking Standards Supplementary Planning Guidance.

DESIGN CONSIDERATIONS

PARKING AREA

2. Motorcycle parking shall be placed as close as possible to a building entrance. Failure to do this is likely to result in obstructive "fly parking" which will detract from the utility of other users.
3. Motorcycles come in a range of shapes and sizes and as such the provision of a parking 'area' usually proves for both flexibility and space efficiency.
4. On-street motorcycle parking usually takes a form similar to a car parking bay. Consequently, dedicated motorcycle parking facilities shall be appropriately signed.
5. Motorcyclists shall be encouraged to park their vehicles perpendicular to the kerb within parking bays. Bays need not be marked out individually.
6. Parking shall be provided on a surface which offers good grip, is well drained, and is relatively flat and firm.
7. Consideration must be given to how motorcycle users will be able to manoeuvre vehicles in/out of the parking provision safely. The definition of usable areas must consider the need to mount and dismount vehicles conveniently.

SECURITY

8. As a minimum, parking facilities shall be located so as to ensure good observation from any buildings and the public realm. Designers shall also consider the use of physical security measures such as rails (Preferred physical security measure), hoops or posts to improve attractiveness to motorcyclists and to further minimise crime risk.
9. Where motorcycles are parked perpendicular to the kerb, a simple continuous steel rail suffices in most situations. An additional waist-high rail shall normally be added to reduce the risk of tripping, particularly where the rail is otherwise exposed to the footway.
10. Facilities shall be well lit and preferably within view of CCTV coverage.
11. When providing motorcycle parking facilities in multi- storey car parks, a dedicated area shall be provided on the ground floor within view of parking attendants.

TECHNICAL CRITERIA

12. 20m - ideal maximum distance of parking provision from main destination.
13. 50m - absolute maximum distance of parking provision from main destination.
14. Parking bay dimensions, where bays are to be marked:
 - 2.1m (length) x 1.4m (width) - minimum.
15. Preferred physical security measure - Rail:
 - 600mm - raised height of any steel rail from the parking surface.

DES 15

Motorcycle Parking

LINKS AND REFERENCES

- a. For further information on motorcycle parking, refer to IHE Guidelines for Motorcycling and DfT Traffic Advisory Leaflet 2/02.
- b. For signing and lining considerations, refer to TSRGD 2016.
- c. This DES should be read in conjunction with Sections 1, 2 and 3 of the Leicester Street Design Guide.

DES 16

Private Accesses, and Off-Street Vehicle Parking and Servicing



DESIGN ELEMENT SHEET

DES: 16

Subject: Private Accesses, and Off-Street Vehicle Parking and Servicing

Date:	17-05-2019	Version:	0.2
Author:	ANS	Approved:	BD

DESIGN CONSIDERATIONS

1. In most types of developments there will normally be some vehicular interface between highway and private space to allow access and egress, generally for parking or servicing.
2. The exception to this may be:
 - car-free developments, where no parking is provided whatsoever;
 - developments where parking is provided entirely on-street; or
 - commercial developments in city centre and other dense urban areas where staff and visitor parking may be accommodated in a commercial third-party car park, and where servicing takes place wholly on-street

VEHICLE ACCESS TO RESIDENTIAL DWELLINGS

3. The normal presumption is that dwellings will front onto residential streets and take direct access from it. Direct frontage access helps to generate activity and a positive relationship between the street and its surroundings. Providing direct access to buildings is also efficient in land-use terms.
4. This principle also applies to existing streets on the edges of development sites. In most cases in urban areas it will not be necessary to set new dwellings back from an existing street, accessed via an unnecessary shared private drive.
5. Direct vehicular access to dwellings is typically provided through an individual private

- driveway or a shared private driveway to five or fewer dwellings; for guidance on the latter see DES-07.
6. The design requirements for new-build private driveways are the same as those for applications for new crossovers at extant properties.
7. If the new highway being created is expected to be classified A, B or C road, the appropriateness of taking direct access will need to be discussed and agreed with the highway authority.
8. Private driveways shall be a minimum 15 metres from the tangent point of a junction with a classified (A, B, C) road.
9. Sightlines shall be adequate, including for pedestrians and cyclists.
10. Sufficient space must exist within the property for vehicles to park without encroaching onto the highway. Where the driveway serves more than two parking spaces, adequate space must be available for vehicles to turn around within the property.
11. The highway authority may request tracking analysis if manoeuvrability is a concern, particularly if driveways are close to traffic calming features, traffic signals or crossings.
12. In designing vehicular accesses to dwellings, designers must also take into account:
 - The latest issue of the Building Regulations Approved Document B, Fire Safety, as emergency vehicle needs are normally governed by fire service requirements.

DES 16

Private Accesses, and Off-Street Vehicle Parking and Servicing

4

- Waste collection requirements as set out in British Standard 5906:2005. This is particularly important when shared private accesses are to be provided.
 - Where private driveways and other unadopted surfaces fall towards the public highway, surface run-off must be prevented from reaching the highway drainage system.
 - If applicable, vertical traffic calming features shall not be sited in close proximity to entry points to prevent vehicles grounding, as they turn in or out of the access.
 - Any street name plates on a private driveway or unadopted vehicular access way must clearly state that the driveway is 'private' and must remain in place as long as this is the case.
 - It is important that there is clear demarcation between public and private space. The highway boundary shall normally be defined by continuous 50mm x 150mm edging type EF to BS7263 unless agreed otherwise with the LHA (see DES-01). Alternative approaches to demarcation may be considered on a site-by-site basis, for example, in conservation areas.
 - On-street parking facilities shall be located so as not to prevent vehicles from accessing driveways, particularly refuse vehicles or when access is required by HGVs.
13. In line with BS 5906:2005, vehicular accesses to dwellings must consider that:
- Refuse collection vehicles and fire vehicles shall not normally be required to reverse more than 12m and 20m respectively.
 - Waste management collectors shall not normally be required to carry individual waste containers or move two-wheeled containers for a distance of more than 15m.
- Waste management collectors shall not be required to manoeuvre four-wheeled waste storage containers from the storage points to collecting vehicles for a distance of more than 10m.
 - Bin storage areas shall be immediately adjacent to the public highway, as Leicester City Council waste collectors are not authorised to enter private land to discharge their duties.
14. To emphasise the distinction between public highway and private space, and to minimise disruption to the footway, private access for off-street parking shall normally be constructed with a dropped kerb, i.e. a "footway crossover".
15. A footway crossover is a continuous, unobstructed and adequately strengthened surface that enables vehicles (e.g. cars, light and heavy goods vehicles) to traverse the footway. It normally provides a point of entry for motorised vehicles to an individual/shared off-street parking facility whilst maintaining pedestrian priority along the footway.
16. Footway crossovers shall not ramp up the full width of the footway. Crossfalls shall not adversely affect users passing along the footway.
17. Where footway crossovers are provided to private accesses that facilitate heavy goods vehicle movements (e.g. for deliveries or servicing purposes), crossovers need to be strengthened. Special attention must be paid to the possibility of refuse vehicles using the footway crossover.
18. The use of tactile paving is not required at footway crossovers. The footway surfacing material shall remain unchanged through the crossover so that visual continuity is maintained.

DES 16

Private Accesses, and Off-Street Vehicle Parking and Servicing

19. Kerbed radii at private accesses shall only be provided where agreed with the LHA at the pre-application stage. This will normally reflect land use and expected vehicle movements.

OFF-STREET VEHICLE PARKING

20. An appropriate car parking strategy matching supply to demand is imperative for the success of any development and key to a successful parking strategy.

21. Off-street vehicle parking for dwellings generally takes one or a mixture of the following:

- Hardstanding, for the exclusive use of the property
- Garage, for the exclusive use of the property
- Allocated parking in a parking court

22. Rear parking courts are generally discouraged.

23. Hardstanding and parking courts shall be well lit and close to the dwelling(s) they serve.

24. Hardstanding shall preferably be provided either directly in front of or to the side of the property served (or both) where it has good visibility and convenient access to the street. Suitable clearance to the front door and car doors must be provided.

25. In the interests of crime prevention, hardstanding should enjoy observation from a window to the side of the property and/or good natural observation from neighbouring buildings.

26. Parking spaces that are allocated to individual dwellings shall be clearly distinguishable from one another.

27. Separate parking areas that are remote from some or all the properties that they serve, and which cannot be easily observed – particularly rear parking courts – are not acceptable.

28. Tandem parking solutions (where vehicles are intended to park one behind the other on a

hardstanding) shall only be permitted for a maximum of two vehicles

29. Where a property contains a garage to be counted as a parking space with a further parking space located in its hardstanding forecourt, this also classifies as a tandem parking solution

30. Garages shall normally be counted as car parking spaces if they meet or exceed the 'Preferred' Minimum standard set out in TABLE XX. Garages that fall short of the Minimum standard shall be excluded from classification unless otherwise agreed with the LHA.

31. Where an integral garage is proposed (i.e. the garage is part of the house), early discussions on the preferred design of the garage, the house and elevation of the property shall be held with the LPA.

32. In conventional streets, on-plot garages to individual properties shall be preferably located so that:

- Cars can park off the highway in front of the garage doors.
- The garage doors can be opened while the vehicle is on the drive without the vehicle obstructing the adjoining street, including any footway or turning facilities.
- Appropriate set-back distances from garage doors to the highway boundary are shown in Table 8.14 below.
- Gated accesses to car parking spaces shall be set back from the highway boundary or back of footway a minimum distance of 5m for residential and 15m for commercial developments to ensure that the public highway (particularly areas used by pedestrians) is not obstructed if a vehicle is parked or stopped on the access in front of the gates.
- Recessed garages or gated accesses with short set-backs from the highway, leading to obstructive parking, should always be avoided.

DES 16

Private Accesses, and Off-Street Vehicle Parking and Servicing

4



This off-street parking space is ineffective as the car doors cannot be opened.



Example of a 'garage mews'



Front parking options must be considered to better integrate development-specific parking needs. (Image courtesy of Andrew Beard)



Example of a gated entrance to a car port in a mews street.



Car parking provision using cart sheds.



New development including parking and garage courts that are secured with electronic gates.

DES 16

Private Accesses, and Off-Street Vehicle Parking and Servicing

33. In shared surface streets it will be acceptable to locate garage doors and gated accesses to car parking spaces at the edge of the adopted highway to create a mews street.
34. The width and layout of the mews street will need to accommodate the swept paths of vehicles entering and leaving the garages and accesses and the need for service vehicle using the street, as well as any on-street parking. Mews streets shall meet the technical requirements for shared surfaces set out in DES-07.
35. On-street parking will also be an important part of the mix; see DES-17 for further guidance.
36. Parking for other types of vehicles, i.e. motorcycles and cycles, also needs to be considered; see DES-15 and DES-14 respectively.

TECHNICAL CRITERIA**ACCESS - FOOTWAY CROSSOVERS**

37. To emphasise the distinction between public highway and private space, and to minimise disruption to the footway, private access shall normally be constructed with a dropped kerb, i.e. a footway crossover.
38. Kerbed radii shall only be provided where agreed with the LHA at the pre-application stage. This will normally reflect land use and expected vehicle movements.
39. Vehicular access design shall be supported by swept path analysis of appropriate vehicles.
40. The width of a private vehicular access shall be:
- 3.7m – access to a single dwelling
 - 4.8m – shared access to 2-5 dwellings (see DES-07)
 - 6m – access to off-street car park or parking court, unless one-way working is

designed, and a narrower access is proved by tracking

- 7.5m – any other type of private access where pedestrians share the vehicular point of access (see DES-07)
41. The width of an access not conforming to any of the above types shall be demonstrated by tracking.
42. A minimum of 900mm width of footway shall be retained at the regular footway crossfall; see fig. 16.3.
43. A minimum kerb upstand of 25mm shall be provided at a vehicle crossover.
44. The above parameters apply only for streets with a design speed of 30mph or less (or an observed 85th percentile speed of 30mph or less). For streets with a higher design or observed speed, access arrangements should be discussed with the LHA.
45. Footway crossovers shall not be located within bus stop cages, car parking spaces, loading bays, crossings or junctions.
46. The approval of the LHA must be obtained for the construction details of the access of any employment or commercial development prior to the submission of an application.

ACCESS - VISIBILITY SPLAYS

47. Pedestrian visibility splays of 2m x 2m shall be required in areas where footfall is above 100 pedestrians per hour at the busiest hour of the day. Sensitive locations, e.g. sites near schools and medical centres, may also require pedestrian visibility splays to be provided. This will be requested by the LHA at the pre-application stage.

ACCESS - GRADIENTS

48. Maximum permitted gradients:
- 1:20 or less for the first 5m for a single residential dwelling and 2 to 5 residential dwellings.

DES 16

Private Accesses, and Off-Street Vehicle Parking and Servicing

- 1:20 or less for the first 15m for B1 use class developments of up to 3,000m² GFA.
- 1:12 shall never be exceeded in all cases, in keeping with BS 5906:2005.

ACCESS - SURFACING

49. Bound material, for example, bituminous, concrete or block paving for at least the first 5m for residential developments and 15m for B1 use class developments of up to 3,000m² GFA.

ACCESS - TURNING AREAS AND SERVICING

50. Accesses may require internal turning areas in certain circumstances. These are set out in DES-06.

51. Development needs, e.g. servicing, shall also determine the requirement for internal turning areas.

52. A delivery and servicing plan (DSP) may be specified by the LHA at pre-application stage or conditioned upon consent being granted to demonstrate that vehicle movements for servicing will be suitably managed and not significantly impact on the highway and neighbouring properties.

CAR PARKING SPACES - QUANTITY AND SIZE

53. The number of car parking spaces provided in new developments shall be in accordance with Leicester City Council Supplementary Planning Guidance: Vehicle Parking Standards.

54. Where on-street spaces are clearly defined, in accordance with DES-17, they shall be considered to contribute towards the overall level of car parking provided by the development.

55. Minimum standard car parking bay dimensions:

- Parallel to the kerb: 2.0m W x 5.5 m L
- Perpendicular and echelon parking bays: 2.4m W x 5.5m L

56. Minimum disabled persons' parking bay dimensions:

- Parallel to the kerb: 6.6 m L x 2.7 m W
- Perpendicular and echelon bays: 6.6 m L x 3.6 m W

57. Parking court and car park aisles shall be 6 m wide, unless:

- One-way working is in operation and satisfactory manoeuvrability is proved by tracking.

58. Narrower aisles may necessitate wider parking bays being provided.

59. Designers shall add 0.5 m to dimensions if bounded by a wall, fence, hedge, line of trees or other lateral obstruction to one side; or add 1m if bounded on both sides.

60. Where electric vehicle charging equipment is to be provided, this shall only be located in the following positions:

- In a furniture zone on the carriageway side of the footway that keeps clear the agreed usable footway width
- On a build out or protected island between the ends of two parking bays or at the end of a parking bay

61. Where passive provision is designed in, this shall conform to the requirements set out in the above paragraph.

62. Electric vehicle charging equipment shall not be placed within the vehicle circulation areas.

63. Parking courts shall be counted as allocated parking. Parking courts must be located with active frontage. Rear parking courts shall not be permitted because this presents problems of security and anti-social behaviour.

64. Wheel stoppers shall be provided within echelon or perpendicular parking bays that abut a footway or cycle track.

65. Wheel stoppers are also highly desirable where the parking of long vehicles is likely, as

DES 16

Private Accesses, and Off-Street Vehicle Parking and Servicing

obstruction of pedestrian routes or damage to edge treatments may otherwise occur.

- 66. Internal circulation of car parking areas, including manoeuvring into and out of spaces, shall be proved by tracking.

GARAGES

- 67. The following dimensions are the minimum sizes permitted:

Table 16.1 – minimum garage dimensions

Type of garage	Internal dimension for garage (Width x Length)	Garage door (Width)
Standard single	3.0m x 6.0m	2.3m
For use by people with a disability	3.3m x 6.0m	2.8m
Double garage	6.0m x 6.0m	4.2m

- 68. Spaces that are smaller may still be proposed but are unlikely to count in parking totals. Where larger vehicles are expected, garage sizes in excess of these minima should be provided.
- 69. Garages shall be set back from the highway boundary by a distance that reflects the type of door in use, as set out in table 16.2 below. This ensures that vehicles do not obstruct the footway or highway when waiting for doors to open or close.

Table 16.2 – minimum garage dimensions

Garage door type	Distance from highway boundary
Roller-shutter, sliding or inward-opening	5.5m
"Up-and-over"	6.1m
Hinged, outward opening	6.5m

- 70. Again, where larger vehicles are expected, garage set back distances shall be extended at the request of the LHA at the pre-application stage.

ADOPTION AND MAINTENANCE

- 71. The approval of the LHA must be obtained for the construction details of the access of any employment or commercial development prior to the submission of an application.
- 72. Wheel stoppers in parking areas that are subject to adoption shall incur a commuted sum.
- 73. The LHA will not adopt off-street parking areas. Where they are proposed developers, shall provide clear details of future maintenance responsibilities; see DES-07.

LINKS AND REFERENCES

- a. For long driveways and accesses (over 25m), the developer shall refer to BS5906:2005 for further guidance.
- b. For further details relating to private roads and the emergency services, refer to the latest issue of the Building Regulations Approved Document B, Fire Safety.
- c. For further details relating to accessible homes, refer to the Lifetime Homes Design Guide.
- d. For further guidance and case studies on parking, refer to Rudlin and Sampson (2014) 'Space to Park'.
- e. For information about how to help promote personal safety and security see the Secured by Design (SBD) toolkit and other SBD documentation as below:
 - Design Council (2011) Designing out crime: A designers' guide.
 - ACPO Crime Prevention Initiatives (2014) Secured by Design: New Homes 2014.
- f. Leicester City Council (2006) Supplementary Planning Guidance: Vehicle Parking Standards
- g. This DES should be read in conjunction with Sections 1, 2 and 3 of the Leicester Street Design Guide.

DES 17

On-Street Vehicle Parking and Servicing



DESIGN ELEMENT SHEET

DES: 17

Subject: On-Street Vehicle Parking and Servicing

Date:	17-05-2019	Version:	0.2
Author:	ANS	Approved:	BD

DESIGN CONSIDERATIONS

4

1. On-street car parking spaces provides a flexible resource for residents and visitors. Carefully designed car parking can play a positive role in calming traffic speeds by encouraging motorists to drive slower and more responsibly. When integrated with other design elements which break up extensive areas of car parking (e.g. trees, SuDS, etc.) and consideration is given to ensure that parking spaces are conveniently located and overlooked, on-street spaces can be successfully assimilated into the built environment.
2. On-street spaces can also cater for demand for parking larger vehicles, such as vans.
3. The following matters shall be taken into account:
 - On-street parking areas should be clearly defined so to encourage the intended users to use them. Parking space definition can be achieved through road markings but preferably through material differentiation, which can contribute positively to achieving a sense of place.
 - Traffic Regulation Orders shall be considered to minimise the risks of on-street parking particularly near schools.
 - The arrangement of parking shall not cause undesirable obstructions, for example to pedestrian and cycle movement; visibility at junctions; and the safe and efficient operation of buses, emergency vehicles and refuse collection vehicles.

- Parking provision shall aim to ensure that the level and design of on-site parking and any proposed travel plan measures reflect and complement each other.

TECHNICAL CRITERIA

4. An appropriate car parking strategy matching supply to demand is imperative for the success of any development and key to a successful parking strategy.
5. The number of car parking spaces provided in new developments shall be in accordance with Leicester City Council Supplementary Planning Guidance: Vehicle Parking Standards.
6. Where on-street spaces are clearly defined, in accordance with this DES, they shall be considered to contribute towards the overall level of car parking provided by the development.
7. Minimum standard car parking bay dimensions:
 - Parallel to the kerb: 2.0m W x 5.5 m L
 - Perpendicular and echelon parking bays: 2.4m W x 5.5m L
8. Minimum disabled persons' parking bay dimensions:
 - Parallel to the kerb: 6.6 m L x 2.7 m W
 - Perpendicular and echelon bays: 6.6 m L x 3.6 m W
9. Where electric vehicle charging equipment is to be provided, or passive provision is designed in, an extra 1m length shall be added to the parking space for this purpose. This shall be reduced to 0.5m if the equipment is shared between two adjacent parking bays.

DES 17**On-Street Vehicle Parking and Servicing**

10. Electric vehicle charging equipment shall not be placed within the vehicle circulation areas. Electric vehicle charging equipment shall not be placed within the pedestrian circulation area unless additional width is added to the footway to compensate.
11. To minimise the risk of collision between cyclists and car doors, a buffer zone of at least 0.5 metres must be provided the edge of parallel car parking spaces and cycle lanes or tracks.
12. Disabled persons' parking bays shall be located where road gradient and camber are reasonably level and no steeper than 1:50. Dropped kerbs must be provided for wheelchair users where designated bays are at a different level from the adjacent pavement.

ADOPTION AND MAINTENANCE

13. On-street parking shall be considered within tracking assessments to determine suitable carriageway widths.
14. Allocated on-street parking cannot form part of the public highway so shall not be adopted.

LINKS AND REFERENCES

- a. See DES-06 for more information on minimum carriageway widths.
- b. See DES-16 for off-street parking guidance.
- c. For further guidance on disabled persons' parking facilities, refer to DfT Inclusive Mobility.
- d. For advice on the provision and design of parking for disabled people, refer to DfT Traffic Advisory Leaflet 5/95 and BS 8300:2009+A1:2010.
- e. For more information on on-street parking design, see the CIHT guidance note on residential parking.
- f. For further guidance and case studies, refer to Rudlin and Sampson (2014) 'Space to Park'.
- g. This DES should be read in conjunction with Sections 1, 2 and 3 of the Leicester Street Design Guide.



DESIGN ELEMENT SHEET

DES: 18

Subject: Drainage

Date:	17-05-2019	Version:	0.2
Author:	ANS	Approved:	BD

GENERAL GUIDANCE

4

1. The National Planning Policy Framework (NPPF) requires that new development is directed away from areas at risk of flooding, but where development is necessary, making it safe without increasing flood risk elsewhere. The provision of suitable highway drainage is a critical part of an integrated surface water management strategy for new developments.
2. LHA's have a duty to make sure that developments include satisfactory arrangements for draining the adoptable highway. The City Council acts as Local Lead Flood Authority (LLFA) for all watercourses, except those classed as 'main river' which are the responsibility of the Environment Agency. Therefore the LLFA (and EA, where appropriate) shall be consulted to agree the overarching principles for the management of surface water for new developments.
3. Street drainage on new developments typically consist of kerbs, channels, gullies, and drainage pipes and is normally connected to a surface water drainage system that is adopted by the sewage undertaker and is subject to a Section 104 Agreement under the Water Industry Act 1991.
4. Applicants must engage the LPA, LHA, LLFA and other interested parties at the outset of the design process to discuss these proposals. This will usually be at the concept development stage.
5. If required, other options might also be considered, including methods where water is drained by a piped drainage system running to

an out-fall adopted by the sewage undertaker or an out-fall to a ditch or watercourse agreed by the Environment Agency or LLFA. In order to ensure no increase in flood risk to others, the location and rate of discharge shall always be agreed with the appropriate approving body.

6. Developers shall also ensure that climate change is considered within the management of surface water, and reference shall be made to the latest guidance on climate change published by the Environment Agency and DEFRA.
7. In all cases, preferred techniques shall ensure that there is no increase in the rate of discharge of surface water run-off, leading to the increase in downstream flood risk, and that design solutions help take out pollutants.

HYDRAULIC DESIGN PRINCIPLES

8. Hydraulic designs of adoptable piped drains must meet the requirements of the current edition of 'Sewers for Adoption' published by WRc plc, and any further requirements of individual sewerage undertakers. The applicant must submit to the relevant case officer detailed calculations using the specified method of calculation and format, and demonstrate the approval of the adopting body.
9. LHAs will accept output from approved computer programmes using the specified method and parameters.
10. Designers must protect streets against flooding. The system shall be designed not to flood any part of the street or site in a 1

DES 18
Drainage

in 30 year return period design storm or any other return period that is set out in any latest version of 'Sewers for Adoption'. Furthermore, designers shall also incorporate the effects of climate change in accordance with the latest Environment Agency and DEFRA guidance.

11. As part of the wider surface water management strategy, the development layout and proposed finish levels shall demonstrate the extent and overland routing of surface water runoff arising from storm events above the design storm i.e. above the 1 in 30 year return period.

DRAINAGE SYSTEMS

HIGHWAY DRAINS

12. Highway drains shall be designed and installed to serve adoptable carriageways, footways and verges (i.e. adoptable streets) where the drainage infrastructure is not adoptable by the sewerage undertaker. Designers must take into account the following:

- The minimum pipe diameter for adoptable street drains, other than gully connections, is 225mm.
- All highway drains shall be normally located within land that the LHA will be adopting. Subject to agreement, the LPA, LHA or water company may consider and permit drains in land expected to remain private, including components associated to SuDS features.
- Designers must select correct cover for any adoptable street drain to be installed outside the limits of the adoptable street by an easement agreement. Suitable arrangements shall be in place before, or be a condition of, the Section 38 or 278 agreement.
- The LHA will not adopt a street unless its associated drainage is to be adopted either by a sewerage undertaker or by them.
- Where private non-adoptable driveways

and other surfaces fall towards adoptable streets, designers must prevent surface water run-off from reaching the street boundary and entering the street drainage system. LHAs will not normally accept drainage of other non-adopted areas into an adopted street.

- In general, the drainage of most other areas of a development are matters for sewerage undertakers. These drainage systems shall normally be designed in line with the water companies' specifications and requirements.
 - Highway drains must be laid:
 - In straight lengths.
 - To straight grades between catchpits (See the Catchpits and Manholes DES).
 - Within the carriageway or verge.
 - Designers must not lay drains and sewers and their associated catchpits or manholes in footways, where this space is required for other utility apparatus. Notwithstanding the need to integrate the design of drains and utility components, the position of catchpits and manholes must reflect an integrated approach to health and safety to allow adequate and safe access to chambers.
13. Where there is or is likely to be run-off from landscaped areas, open spaces and adjoining land, applicants must make appropriate arrangements for land drainage. This can include providing intercepting drains and ditches with satisfactory outfalls. Early discussions shall be held with the adopting body in this respect.

DES 18
Drainage

14. For the purpose of achieving good highway design outcomes, it is recommended that the following points be considered:

- The applicant must include a system of sub-soil drainage to a suitable agreed outfall to the LHAs' satisfaction where:
 - The winter height of the water table is within 600mm of formation level.
 - The sub-soil is unstable because of being waterlogged.
 - There is a likelihood of water running from or out of adjacent ground.
 - Springs, land drains or watercourses are present.
 - The finished street is below existing ground level, regardless of the water table.
 - The sub-grade is likely to be altered due to groundwater.
- Designers shall take care to avoid water ponding in the
- transition length when the longitudinal gradient is flat or where there are traffic islands, central reserves or traffic-calming measures. Water ponding must be avoided particularly on footways/footpaths, in and around bus passenger waiting areas/cycle provisions and at the carriageway kerbside.
- The applicant must deal with any drainage systems existing within the development site including land drains, ditches, watercourses, outfalls from adjacent land or drainage systems to the satisfaction of the relevant LHA and that of the Environment Agency and the owner of the systems.
- The applicant must provide written evidence of the right to discharge water from a highway drain into any receiving ditch or watercourse with no liability on the LHA. The LLFA or Environment Agency, as appropriate, will approve all

such discharges. Written evidence must be provided to demonstrate the applicant has received any approval and consents needed.

15. Designers must take into account the following references:

- Sewers for Adoption
- Leicester City Council Sustainable Drainage Guidance

SUSTAINABLE DRAINAGE SYSTEMS

16. The application of Sustainable Drainage Systems (SuDS) is strongly encouraged by the authority. Leicester has comprehensive existing guidance on SuDS, which should be consulted before the design concept stage.



Sustainable drainage can be incorporated into street layouts in a way that contributes to good urban design and an attractive public realm



The use of SuDS shall be discussed with relevant planning, highway and the local lead flood authorities from the outset of the collaborative design process.

DES 18 Drainage

PIPED DRAINAGE SYSTEMS

17. The following are key considerations in relation to piped drainage systems:

- The end of the pipe must have a headwall and apron that supports the bank above and adjacent to the pipe and prevents any scouring underneath the pipe.
- The banks of the ditch or watercourse must be protected from scouring.
- Any requirements laid down by the Environment Agency must be met.
- If the proposed outfall is to an existing highway drain, its capacity and condition has to be proved before the connection can be proved.
- Where a piped system discharges into an existing ditch or watercourse, the pipe invert (bottom of the inside of the pipe) must not be lower than the level of the average flow in the ditch or watercourse and it shall always be at least 150mm above the ditch or watercourse invert.
- The end of the pipe must be directed so it discharges at an angle less than 60 degrees to the direction of flow in the ditch or watercourse.
- For all works incorporating highway drainage the applicant will need to carry out and prove a copy of a CCTV survey and report. The applicant must carry out any improvement works found necessary, all at the applicant's expense.
- The applicant must have the consent of the Environment Agency for piping an existing ditch or watercourse, in accordance with Section 23 of the Land Drainage Act 1991.

COMBINED KERB DRAINAGE SYSTEMS

18. Combined kerb and drainage systems are not normally acceptable to the LHA due to maintenance liability. Where their use is unavoidable, this should be agreed with the

LHA during the design process. Where a combined kerb and drainage system is agreed, it shall attract a commuted sum when offered for adoption.

HIGHWAY DRAIN COMPONENTS

CATCHPITS

19. Designers must include a catchpit (an access chamber, with sump, on a drainage system) where there is any discharge into an existing ditch or watercourse.
20. Inset covers may be appropriate at certain locations and be used to enhance the character of the streetscape, particularly in areas of importance, including heritage sites, conservation areas and near listed buildings.
21. Inset covers are not mandatory and the use of these must be agreed with the LHA and utility company on a case-by-case basis.
22. Consultation shall also be undertaken with the LHA to confirm any local variations or requirements, including the use of ladders or step irons and any requirement for a badge or logo on chamber covers.
23. Construction quality is critical to ensure service covers are flush.
24. Catchpits shall be used in preference to manholes for highway drains.

GULLIES

25. In footpaths, footways, cyclepaths and cycleways, applicants must provide gullies or channels connected to the adopted drainage system where surface water would otherwise discharge onto adjacent property or cause flooding.
26. Designers must not place gully gratings parallel to cyclists' direction of travel.
27. Designers must not site gullies adjacent to pedestrian crossing points. Where possible, they shall be located directly upstream of the crossing point.

DES 18
Drainage

- 28. Designers shall not site gullies where traffic would be prevented from passing while they are being emptied, for example within a carriageway width restriction.
- 29. Consultation shall be undertaken with the LHA to confirm the requirements for gully pot construction details. All gullies shall incorporate trapped outfalls.

TECHNICAL CRITERIA

CATCHPITS

- 30. Unless otherwise specified, designers must use catchpits and not manholes for highway drains on adoptable street drainage systems.
- 31. The outside of catchpits and manholes shall be at least 500mm from the kerb line or the edge of the carriageway.
- 32. On all adoptable drainage runs, designers must provide a catchpit at:
 - Every change of alignment or gradient.
 - The head of all main pipelines.
 - Every junction of pipelines except for single-gully connections.
 - Every change in pipe diameter.
 - Every change in pipe material.
 - A maximum spacing of 90 metres.
- 33. Designers shall normally locate catchpits or manholes within the verge, and not the carriageway.
- 34. Any catchpits or manholes within a carriageway must be located so that they can be accessed while providing the necessary safety zones and without preventing traffic from passing. This will generally mean that these elements shall not be positioned at or near the centre of the carriageway or within a width restriction. Exceptions may apply for shared-surface streets.
- 35. If located within the carriageway, service covers shall not be placed within the braking

and turning areas for cyclists and motorcyclists. Subject to engineering constraints and the local context, anti-skid treatments may also be required.

- 36. Care shall be taken when locating catchpits or manholes within junctions or roundabouts, based on the same criteria; see DES-19.

GULLIES

- 37. The minimum size for a street gully connection is 150mm.
- 38. The maximum length of a gully connection shall not be more than 15m.
- 39. All gullies shall be trapped. It will not normally be acceptable to connect one gully connection directly into another.
- 40. Gully spacing shall be calculated based on the carriageway gradients and areas drained. Gully spacing is shown within the following table.

Table 18.1 – Standard gully spacing requirements

Gully spacing parameters				
Carriageway gradient	1/100	1/80	1/60	1/40 or steeper
Area drained (m ²) (Note: A)	170 (Note: B)	180 (Note: B)	200 (Note: B)	240 (Note: B)

- a. Includes footways, footpaths, paved areas and verges that fall towards the carriageway.*
- b. Gullies must not be spaced more than 40m apart, irrespective of the areas drained, except at summits where the first gully shall not be more than 40m from the high point. Double gullies must always be provided at sag points and low points and each must have its individual connection to the main sewer or highway drain.*
- 41. Gullies shall be sited upstream of the tangent point at road junctions so that surface water in the channel does not flow across the junction.
- 42. Care will be required to avoid ponding near the mid-point of radius kerbs.

DES 18
Drainage

43. Where the street is super-elevated, gullies shall be sited just before the point where the adverse camber is removed to prevent water in the upstream channel flowing across the carriageway.
44. The applicant must provide the LHA with a contour and drainage catchment plan to show that gullies are located in the correct position as part of the design submission for works under Section 38 or Section 278 agreements.



Typical gully design



Drainage channel and gully in the centre of a carriageway

LINKS AND REFERENCES:

- a. This DES should be read in conjunction with Sections 1, 2 and 3 of the Leicester Street Design Guide.



DESIGN ELEMENT SHEET

DES: 19

Subject: Utilities

Date:	17-05-2019	Version:	0.2
Author:	ANS	Approved:	BD

GENERAL GUIDANCE

4

1. Public utility apparatus is primarily placed within streets so that supply of services to customers is straightforward and the maintenance of equipment can be undertaken efficiently.
2. Utility companies are statutory undertakers who have a legal right to carry out works in the highway under the New Roads and Street Works Act 1991, and in most cases do not require planning permission to install their equipment under the Town and Country Planning (General Permitted Development) Order 1995.
3. Utility equipment can be placed:
 - Above ground, e.g. junction boxes, hydrants, phone boxes
 - Below ground, i.e. pipes and cables
4. It is critical to liaise with the utility companies at an early stage in the design process to consider the location and installation of public utility equipment both above and below ground. This is particularly important where shared-surface streets are used. See also DES-07.
5. Underground utility apparatus shall be laid in 'corridors'. Designers must check specific standards used by utility providers in relation to the placement and depth of utility apparatus in order to cater for current needs and future demands.
6. Simplicity is a desirable attribute in street design that can lead to the more effective and cost-efficient provision of utility infrastructure.

Designers shall consider carefully the benefits and disadvantages of straight street layouts for the purpose of supporting utility infrastructure whilst complementing speed management measures.

DESIGN CONSIDERATIONS

ABOVE-GROUND EQUIPMENT

7. Above-ground utility equipment, for example, cabinets, boxes, pillars and pedestals shall always be kept to a minimum and be sited to ensure:
 - There is safe and convenient access for maintenance purposes.
 - Pedestrian desire lines and cycling routes are unhindered.
 - Visual amenity is not adversely affected for example by restricting the outlook from the window of a house or intruding into areas of open-plan front gardens or disrupting the line of low boundary walls.
 - Important views, for example to listed buildings, are not adversely affected
 - The avoidance of 'visual clutter' by being in an inappropriate place.
 - Be positioned so there is enough access for the equipment and the surrounding highway to be safely maintained and cleaned.
 - Not be located within any tactile paving, including surface covers.
 - Allow space for associated jointing chambers.

DES 19 Utilities



Utility equipment (e.g. cabinets, boxes, pillars and pedestals) is to be located preferably at the back of the footway, away from windows or walls to prevent unlawful access into surrounding buildings.

BURIED SERVICES

8. Designers shall locate equipment below ground in line with NJUG Guidance. The standard arrangement of below ground service equipment within footways is shown within Figure 18.1, over.
9. A similar dedicated corridor for below ground equipment will be required within shared surface streets. It will not normally be necessary or desirable to provide a raised service strip separate from and adjacent to the main shared surface

10. Utility companies must always be consulted to ensure the orientation of equipment satisfies servicing requirements.
11. The route of buried services and their access covers must also be designed to ensure that single points of access or primary accesses do not require a point closure during any utility works.
12. The selection of surface materials shall minimise any adverse impact on good visual appearance as access for maintenance/repairs and future replacement will be required.
13. For development involving off-site utility work under footways and carriageways, the LHA may require full width reinstatements.
14. Low maintenance must be considered so surface materials (e.g. slabs) can be reinstated if lifted off the pavement to enable access to below ground service equipment.
15. It is particularly important to coordinate utility routing plans and the position and planting arrangements of street trees.

DES 19
Utilities

4

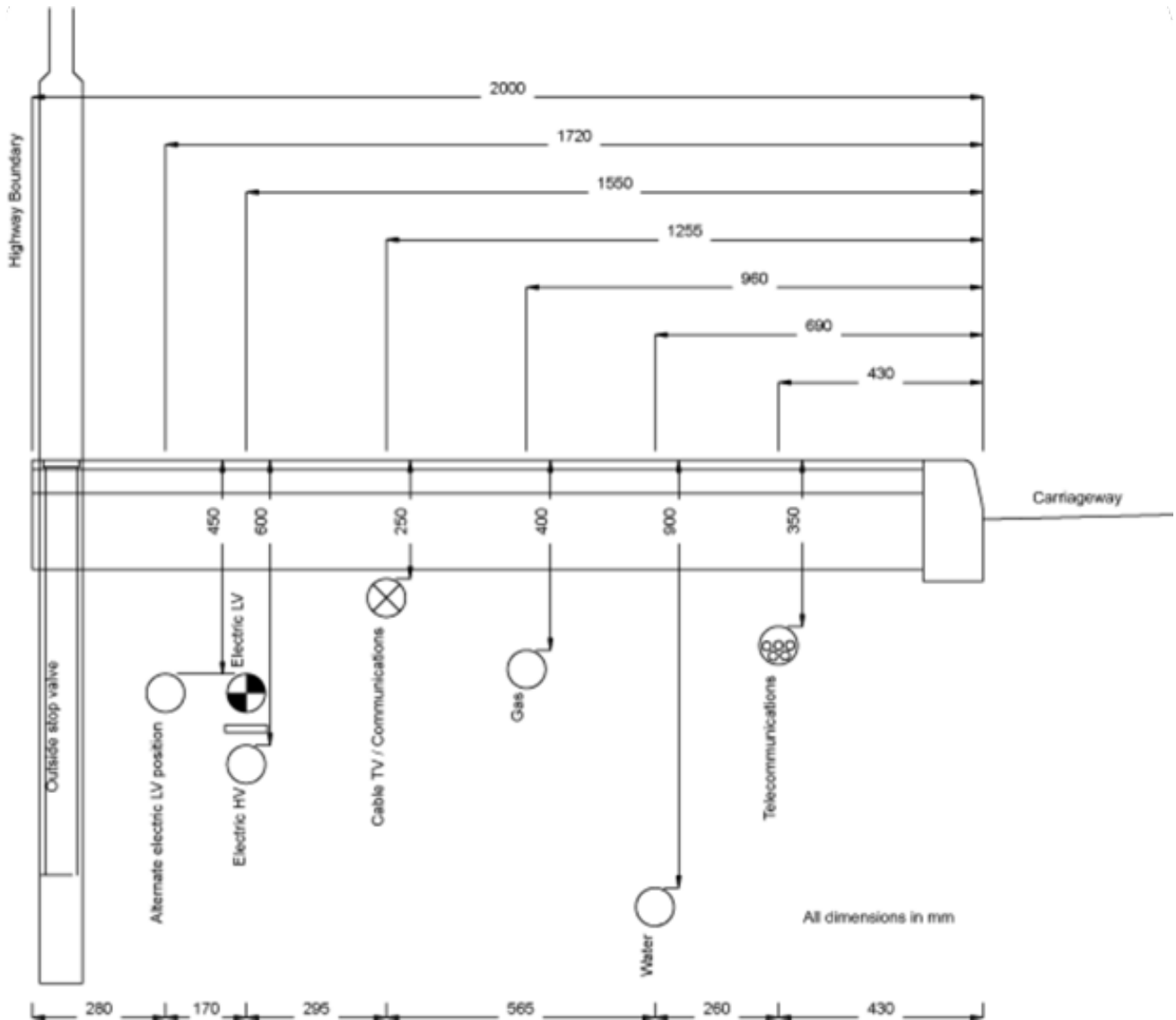

Fig 18.1 - Standard arrangement of buried utility runs

INSPECTION COVERS AND ACCESS CHAMBERS

- 16. Orientation must be considered when positioning inspection covers and access chambers. This is particularly important in relation to block-paved surfaces and kerb edges.
- 17. Neat joints (equipment laid parallel) shall be provided both at the back of the footway and the kerb edge.

- 18. Inspection covers shall be placed in an inconspicuous manner, particularly in conservation areas.

DES 19 Utilities



Where possible the orientation must be considered when positioning inspection covers and access chambers. In this example the nearest cover respects the blockwork pattern but the two further away do not



Attention to detail around covers can have a positive effect in the appearance of a street. Good construction methods are also critical for the purpose of safeguarding safety of the scheme



Inspection cover with paving sets inserted to align with the surrounding paving. Design and construction of inset covers must take into account the orientation of paving materials and cost implications i.e. particularly maintenance costs and safety of two-wheelers

19. Inspection covers and access chambers on the surface must reflect an integrated approach to health and safety to allow adequate and safe access. Access chambers must:

- Be located to minimise disruption to pedestrians and provide adequate access for installing and maintaining equipment.
- Be located away from areas where they may pose a slippage risk to cyclists and motorcyclists (see TfL Urban Motorcycle Design Handbook)
- Take into consideration boarding and alighting zones to avoid future difficulties during maintenance works.
- Avoid positioning inspection covers where changes in levels occur, for example, dropped kerbs.
- Allow for using mechanical equipment during construction and installation, maintenance and recovery operations at the site.
- Take into account any known highway alterations.
- Make sure the type and construction of underground boxes takes into consideration the potential need to raise inspection covers and frames, for example, when resurfacing work is carried out.
- Avoid any interference with archaeological features, foundations to listed buildings and street trees.

TECHNICAL CRITERIA

20. Any utility equipment that is above ground shall be sited so that it:

- Provides a clear footway width of at least 1.2m clearance so that equipment does not obstruct pedestrians, wheelchairs, prams, pushchairs, etc. In areas of high pedestrian activity (i.e. pedestrian flows over 500 pedestrians an hour), the clearance provided shall be increased to at least 2.0m

DES 19
Utilities

4

- Is not located within 5m of any other street furniture that would create a double obstruction to pedestrians. Any items within 5m must be in line with one another.

21. Utility equipment is to be located preferably at the back of the footway, away from windows or walls to prevent unlawful access into surrounding buildings. Access doors to any utility equipment shall open to the footway.
22. Utility strips are confusing for pedestrians as they resemble narrow footways. Utility service strips shall not be provided unless exceptional circumstances dictate and this has been agreed by the LHA. .
23. Where utility equipment cannot be located in the footway, it may be located in a verge with a suitable hard surface area, at least 500mm wide, around the equipment to facilitate the maintenance of the verge.
24. Where utility equipment is located in a verge, designers must allow utility operatives to face towards the carriageway or any oncoming traffic when opening the doors.
25. Careful consideration must be given so that utility equipment does not affect street trees and other planting.
26. There shall be at least 1m between the utility equipment and the edge of the carriageway in rural areas and 1.5m in urban areas.
27. The placement of new telecoms equipment in existing highways shall comply with the 'Cabinet Siting and Pole Siting Code of Practice' issued by the Planning Officers Society.

ADOPTION AND MAINTENANCE

28. If applicants cannot meet requirements within adoptable areas, utility equipment may be located off the proposed adoptable highway although an easement will be required to allow utility equipment providers access in future for maintenance purposes.

29. Local authorities and utility companies must advise on specific requirements when utilities are to be placed over, under or near highway structures.
30. Legal documentation required by the relevant utility companies must be completed as soon as possible for all adoptable streets.

LINKS AND REFERENCES

- a. DfT (2005) Inclusive Mobility
- b. Cabinet Siting and Pole Siting Code of Practice, 2016:
<https://www.gov.uk/government/publications/cabinet-siting-and-pole-siting-code-of-practice-issue-2-2016>
- c. NJUG (2007) Guidelines for the Planning, Installation and Maintenance of Utility Apparatus in Proximity to Trees.
- d. TfL Urban Motorcycle Design Handbook.
- e. This DES should be read in conjunction with Sections 1, 2 and 3 of the Leicester Street Design Guide.



DESIGN ELEMENT SHEET

DES: 20

Subject: Street Lighting

Date:	17-05-2019	Version:	0.2
Author:	ANS	Approved:	BD

GENERAL GUIDANCE

1. A suitable system of street lighting on all adoptable streets is required which meets the approval of the LHA. Street lighting design should be considered at the beginning of the design process.
2. Before undertaking the street lighting design, the LHA shall be contacted to obtain the design specification and to determine a design control process.
3. The design shall demonstrate how the design will illuminate different areas of the scheme sensitively to optimise road safety and to promote personal safety and security. The design shall also demonstrate how the design is integrated with drainage, parking and the provision of street furniture, including utility equipment, trees and other planting. The design shall also include, where applicable, illuminated traffic signs (See DES-12)
4. Street lighting efficiency and technical performance are critical. The LHA will be able to provide further details in terms of specific design specifications that currently meet performance requirements whilst helping reduce future maintenance costs.
5. Designers should favour the use of energy effective solutions over the lifetime of the scheme.
6. In order to minimise crime opportunities, the design of street lighting shall be supplemented by the successful application of key urban design principles. For example, buildings that face the street, with more doorways, frontages and more activity at street level.

DESIGN CONSIDERATIONS

7. Lighting shall be planned at the same time as the street layout is designed.
8. Opportunities to reduce street clutter shall be considered, particularly when on-street parking is permitted. Street lighting columns may be used to mount small traffic signs subject to the LHA agreement.
9. The lighting system shall be designed to reflect the scale of surrounding buildings, the proposed width of the street and height of the building when development proposals are being prepared.
10. Special attention shall be paid to providing a sufficient level of lighting along pedestrian and cycle routes, as well as at crossing points and public transport facilities. Street lighting columns must not obstruct these provisions.
11. Provision of lighting at a reduced height may be considered along cycle tracks.
12. Lighting levels shall be maintained at the same standard along a route, whether a route is adopted or not, to encourage pedestrians to use a route and to feel safe.
13. Street lighting columns will normally be acceptable within visibility splays subject to agreement with the LHA.
14. To control light pollution, high light intensity or lighting spilling out on to the surrounding buildings must be avoided.
15. The use of trees and planting in street design shall not reduce the illumination that the street (particularly the footway) receives from street lighting.

DES 20
Street Lighting

4

16. Street lighting and tree planting shall be integrated in accordance with the Code of Practice stipulated in BS 5489-1:2013, paragraph 4.3.3.2.
17. Standard street lighting specification comprises of painted steel columns with road-lighting lanterns of the appropriate height and wattage.
18. Wall-mounted lighting on buildings may also be proposed and will be considered on a case by case basis. The ability to access and maintain the lighting units and power supplies will be a key consideration for the LHA. The developer will be responsible for securing all wayleaves from the final owner of the building.



Wall-mounted lighting

TECHNICAL CRITERIA

19. The design of street lighting shall comply with BS 5489-1:2013.
20. The city street lighting specification will be issued to developments upon application to:
lighting.client@leicester.gov.uk

ADOPTION AND MAINTENANCE

21. Prior to the implementation stage, the developer shall be responsible for the installation of power and lighting equipment, and provide certification of compliance with BS7671:2008
22. The developer shall also ensure that the approved specification of lighting equipment is consistent with:
 - The actual specification of the equipment to be installed; and
 - The designer's risk assessment for the lighting scheme.
23. Prior to the implementation stage, the developer shall be responsible for the installation of power and lighting equipment, and provide certification of compliance with BS7671:2008
24. The developer shall also ensure that the approved specification of lighting equipment is consistent with:
 - Section 38 agreements: If there are more than three years between:
 - Beginning the work and issuing the final certificate; or
 - Completing the Section 38 agreement and issuing the final certificate.
 - Section 278 agreements: If there are more than two years between:
 - Beginning the work and issuing the final certificate; or
 - Completing the Section 278 agreement and issuing the final certificate.
25. Street Lighting attracts commuted sums. See *Redrow Homes v Knowsley Metropolitan Borough Council*.

DES 20
Street Lighting**LINKS AND REFERENCES**

- a. BS 5489-1:2013. Code of practice for the design of road lighting. Lighting of roads and public amenity areas (Part 1).
- b. BS EN 40. Lighting columns.
- c. Highways England Specification for Highway Works, Series 1300 and 1400.
- d. BS7671:2008 incorporating Amendment 3:2015 (The IEE Wiring Regulations).
- e. Sustrans (2012) Lighting of Cycle Paths.
- f. This DES should be read in conjunction with Sections 1, 2 and 3 of the Leicester Street Design Guide.

urban
movement

Urban Movement Ltd
Exmouth House,
3-11 Pine Street,
London EC1R 0JH
+44 (0)20 3567 0710
www.urbanmovement.co.uk



PHIL JONES ASSOCIATES
transport planning consultants